

U.S. NAVY SALVOR'S HANDBOOK





DISTRIBUTION STATEMENT A: THIS DOCUMENT HAS BEEN APPROVED FOR PUBLIC RELEASE AND SALE; ITS
DISTRIBUTION IS UNLIMITED.

PUBLISHED BY DIRECTION OF
COMMANDER, NAVAL SEA SYSTEMS COMMAND

1 JANUARY 2021



TECHNICAL MANUAL CERTIFICATION SHEET

CERTIFICATION APPLIES TO: NEW MANUALS <input type="checkbox"/> REVISION <input checked="" type="checkbox"/> CHANGE <input type="checkbox"/>					
APPLICABLE TMINSPUB. NO.		PUBLICATION DATE (day, month, year)		READING GRADE LEVEL (RGL)	
S0300-A7-HBK-010		01,Jan,2021			
TITLE U.S. NAVY SALVOR'S HANDBOOK					
TMCR/TMSR/SPECIFICATION NUMBER N/A					
CHANGES AND REVISIONS: PURPOSE Update references and cleaned up drawings and images that were not clear.					
EQUIPMENT ALTERATION NUMBERS INCORPORATED N/A					
TMDER/ACN NUMBERS INCORPORATED N/A					
Continued on additional pages as needed.					
CERTIFICATION STATEMENT					
This is to certify that responsible Navy activities have reviewed the above identified document for acquisition compliance, technical coverage and reproduction quality. This form is for Internal Government management use only and does not imply contractual approval or acceptance of the technical manual by Government nor does it relieve the contractor of any responsibilities for delivering the technical manual in accordance with the contract requirements.					
ACQUISITION APPROVAL	NAME Paul Hankins	SIGNATURE  <small>HANKINS.PAUL.FLE Digitally signed by Paul Hankins, DN: cn=Paul Hankins, o=NAVSUP, ou=NAVSUP, email=PHANKINS@NAVSUP.NAVY.MIL, c=US</small> TCHEER.1181197664	ORGANIZATION NAVSEA	CODE 00C2	DATE
TECHNICAL APPROVAL	NAME Richard Thiel	SIGNATURE  <small>Digitally signed by Richard Thiel, DN: cn=Richard Thiel, o=NAVSUP, ou=NAVSUP, email=RTHEL@NAVSUP.NAVY.MIL, c=US</small>	ORGANIZATION NAVSEA	CODE 00C21	DATE 2/10/21
TM MANAGER APPROVAL	NAME Michael Dean	SIGNATURE  <small>DEAN.MICHAEL Digitally signed by Michael Dean, DN: cn=Michael Dean, o=NAVSUP, ou=NAVSUP, email=MD@NAVSUP.NAVY.MIL, c=US</small> S.1228890177	ORGANIZATION NAVSEA	CODE 00CB	DATE 2/10/2021

PREFACE

I received my first copy of the US NAVY SALVOR'S HANDBOOK while a young salvage officer engaged in the raising of the ex-USS BLUEGILL (WWII-era diesel submarine). I found it valuable for two reasons: (1) it contained deck-plate level useful salvage information, and (2) it fit in my hip-pocket. Over the years, most salvors have treasured their dog-eared copy, and are slow to lend it out as it has been too long out of print and hard to find.

This updated version retains both the practical compendium of salvage-related engineering information as well as the "hip-pocket" friendly size. And we're publishing enough copies to ensure broad distribution.

A note to salvors -- this handbook is only a short summary of the hard-earned and sometimes blood-stained knowledge and lessons learned contained in the rich library of the USN Salvage and Diving Program:

- USN Salvage Manuals (6 volumes)
- USN Towing Manual
- Salvage Safety Manual
- Underwater Cutting and Welding Manual
- Use of Explosives in Underwater Salvage
- Salvage Engineering Manual

Be sure to make all of these available in your salvage "ready service" locker as well. Check the SUPSALV website for availability of electronic or CD copies of these manuals.



J. R. Wilkins, III
Director of Ocean Engineering
Supervisor of Salvage and Diving,
USN

DOCUMENTATION MATRIX

The purpose of this matrix is to provide the user of this manual a listing of additional reference documentation. This is given by reference manual and topic area. Information of these manuals is also available on the SUPSALV website and the SUPSALV Tech Doc CD.

TOPIC AREA	SALVAGE MANUAL												
	SAFETY MANUAL	VOLUME 1	VOLUME 2	VOLUME 3	VOLUME 4	VOLUME 5	VOLUME 6	SALVOR'S HANDBOOK	UNDERWATER CUT & WELD	SALVOR ENGINEERING HANDBOOK	TOWING MANUAL	ESSM MANUAL	EXPLOSIVES MANUAL
DAMAGE CONTROL			●				●		●				
STABILITY		●			●		●		●				
SHIP STRENGTH		●			●		●		●				
RIGGING	●	●	●		●	●	●		●		●		
ANCHORS	●	●				●	●		●		●		
STRANDING		●			●		●		●				
PULLING SYSTEMS	●	●					●		●		●		
SAFETY	●	●	●	●	●	●	●	●	●	●	●	●	●
MACHINERY	●						●		●	●	●	●	●
EXPLOSIVES			●				●		●			●	●
HAZMAT	●				●	●			●		●		●
POL	●				●	●			●				
OFFSHIP FIREFIGHTING	●		●		●	●			●		●		
TOWING: POINT-TO-POINT					●						●		
RESCUE			●								●		
PATCHING		●	●				●		●				
COFFERDAMS							●		●				
LIFTING SYSTEMS	●		●		●		●		●		●		
POLLUTION CONTROL	●				●	●	●		●		●		
PONTOONS			●		●		●		●				
SALVAGE PLANNING	●	●	●		●	●	●		●			●	●
PROPERTIES OF MATERIALS		●			●		●		●	●		●	●
CONVERSION FACTORS		●					●	●	●				
COMPUTER PROGRAMMING										●			
DEEP WATER RECOVERY				●			●				●		
CUTTING	●		●					●					●
WELDING	●							●					
CARGO OFFLOAD	●	●			●	●	●		●				

REFERENCE DOCUMENTS

The following manuals/publications are referenced in the matrix:

- SAFETY MANUAL - *U.S. Navy Ship Salvage Safety Manual* (S0400-AA-SAF-010)
- SALVAGE MANUAL - *U.S. Navy Salvage Manual*
 - Volume 1 Strandings, Harbor Clearance, and Afloat Salvage (S0300-A6-MAN-010)
 - Volume 2 Oil Offloading (S0300-A6-MAN-020)
 - Volume 3 Reserved
 - Volume 4 Deep Ocean Search and Recovery (S0300-A6-MAN-040)
 - Volume 5 Canceled
 - Volume 6 Oil Spill Response (S0300-A6-MAN-060)
- UNDERWATER CUT & WELD - *U.S. Navy Underwater Cutting and Welding Manual* (S0300-BB-MAN-010)
- SALVAGE ENGINEER'S HANDBOOK - *U.S. Navy Salvage Engineer's Handbook* (S0300-A8-HBK-010)
- TOWING MANUAL - *U.S. Navy Towing Manual* (SL740- AA-MAN-010)
- ESSM Catalog - Emergency Ship Salvage Material Listing / Descriptions available at:
<https://www.navsea.navy.mil/Home/SUPSALV/ESSM/Salvage-Equipment/>
- NAVAL SHIPS TECHNICAL MANUAL
<https://navsea.navy.deps.mil/field/cnrmc-marmc/200/Pages/NSTM.aspx>
 - Chapter 079 Volume 1 Damage Control Stability and Buoyancy
 - Chapter 079 Volume 2 Damage Control Practical Damage Control
 - Chapter 079 Volume 3 Damage Control Engineering Casualty Control
 - Chapter 079 Volume 4 Damage Control Compartment Testing and Inspection
 - Chapter 096 Weights & Stability
 - Chapter 100 Hull Structures
 - Chapter 555 Volume 1 Surface Ship Firefighting
 - Chapter 555 Volume 2 Submarine Firefighting
 - Chapter 581 Anchoring
 - Chapter 582 Mooring and Towing
 - Chapter 593 Pollution Control
 - Chapter 594 Submarine Escape and Rescue
 - Chapter 613 Wire and Fiber Rope and Rigging

SYMBOLS AND ABBREVIATION

Δ	“the change in...
∇	Volume displacement - see V/Vessel displacement in L tons
a	area
A_M	area of the midships section
AP	after perpendicular
b	width
B	center of buoyancy
b	beam or breadth
BM	transverse metacentric radius
BM_L	longitudinal metacentric radius
BL	baseline
BS	breaking strength
CB	block coefficient
CF	center of flotation
CL	centerline
C_M	midships section coefficient
C_{WP}	waterplane coefficient
D	depth
NP	neutral loading point
F	freeing force
FP	forward perpendicular
G	center of gravity
GG_1	virtual rise in the center of gravity
GM	metacentric height
GM_L	longitudinal metacentric height
GZ	righting arm
I	moment inertia
KB	height of the center of buoyancy above keel
KG	height of the center of gravity above keel

KM	height of the metacenter above keel
KM _L	height of the longitudinal metacenter above keel
KM _T	height of the transverse metacenter above keel
I	length
L or LBP	length between perpendiculars
LCG	longitudinal position of the center of gravity
LCB	longitudinal position of the center of buoyancy
LCF	longitudinal center of flotation
LOA	length overall
LWL	length of design waterline
M	transverse metacenter
M _L	longitudinal metacenter
MS	midships section
MTI	moment to change trim one inch
NP	neutral loading point
P	pressure
R	ground reaction
RM	righting moment
T	draft
T _a	draft aft
TC	trim correction
T _{EQ}	equivalent mean draft
T _f	draft forward
T _m	mean draft
TPI	tons per inch immersion
V	displacement volume
VCB	center of buoyancy above the keel
w	weight
W	displacement (weight)
y	distance from the centerline of the ship to the center of gravity of the flooded compartment

TABLE OF CONTENTS

Documentation Matrix	i
Reference Documents	ii
Symbols and Abbreviations	iii
Table of Contents	v

1 INITIAL ACTIONS FOLLOWING A CASUALTY

1-1	INTRODUCTION	1-1
1-2	POLLUTION CONTROL AND CLEANUP	1-1
1-2.1	Pollution Support Systems	1-2
1-2.2	Oil and Hazardous Substance Technical Support	1-3
1-2.3	Directives and Telephone Contacts	1-5
1-2.4	Hazards Materials	1-7
1-2.5	Gas Hazards.....	1-7
1-2.6	Gas Hazard Monitoring Equipment	1-9
1-2.7	Explosions	1-10
1-3	FIREFIGHTING.....	1-12
1-3.1	Fire Prevention	1-12
1-3.2	Fire Types.....	1-13
1-3.3	Firefighting Procedures	1-14
1-3.4	General and Firefighting Protective Equipment	1-14
1-4	RESTORING THE WATERTIGHT ENVELOPE.....	1-15
1-4.1	Determining Flooding Amounts	1-16
1-4.2	Reducing Flood Water Rate	1-16
1-4.3	Stopping Flood Water.....	1-16
1-5	SALVAGE SURVEY.....	1-18
1-6	SALVAGE PLAN	1-18

2 NAVAL ARCHITECTURE

2-1	INTRODUCTION	2-1
-----	--------------------	-----

2-2	COEFFICIENTS OF FORM	2-1
2-3	INFORMATION SOURCES	2-3
2-4	DETERMINING CENTERS, HEIGHTS and OTHER STABILITY MEASUREMENTS	2-5
2-4.1	Center of Gravity (G).....	2-5
2-4.2	Center of Buoyancy (B).....	2-6
2-4.3	Metacenter (M).....	2-7
2-4.4	Righting Arm (GZ).....	2-7
2-4.5	Righting Moment (RM).....	2-8
2-4.6	Trim	2-8
2-5	STABILITY	2-9
2-5.1	Stability Aground	2-9
2-5.2	Free Surface	2-9
2-5.3	Pocketing	2-10
2-5.4	Free Communication.....	2-10
2-5.5	Stability and Tides.....	2-11
2-5.6	Refloated Ship Stability.....	2-11
2-5.7	Transverse Stability	2-12
2-6	WEIGHT AND STABILITY	2-12
2-6.1	Shifting, Adding and Removing Weight	2-12
2-7	IMPAIRED STABILITY	2-15
2-8	STRENGTH OF SHIPS.....	2-16
2-8.1	Damaged Strength.....	2-16
2-8.2	Strength Examinations.....	2-16
2-8.3	Bending Moments	2-17
2-9	TRAPEZOIDAL RULE.....	2-17
2-10	SIMPSON'S RULES	2-18

3 RIGGING

3-1	INTRODUCTION.....	3-1
3-2	FIBER LINE.....	3-1
3-2.1	Fiber Line Property Comparison	3-1
3-2.2	Line Breaking Strength (BS).....	3-3
3-2.3	Line Safe Working Loads (SWL).....	3-8
3-2.4	Line Safety Factor	3-8
3-2.5	Substituting Fiber Line	3-8

3-2.6	Line Bending Radius	3-10
3-3	WIRE ROPE	3-10
3-3.1	Wire Rope Use by Size	3-11
3-3.2	Wire Rope Properties	3-11
3-3.3	Wire Rope Safe Working Load (SWL)	3-11
3-3.4	Bending Wire Rope	3-11
3-3.5	Wire Rope Inspection	3-14
3-3.6	Wire Rope Fittings	3-16
3-4	CHAIN	3-22
3-4.1	Chain Uses	3-22
3-4.2	Chain Construction	3-22
3-4.3	Chain Strength	3-24
3-4.4	Chain Safety Factor	3-28
3-4.5	Chain Inspection	3-28
3-4.6	Chain Connecting Hardware	3-29
3-5	ANCHORS	3-31
3-5.1	Anchor Types	3-31
3-5.2	Anchor Holding Power	3-31
3-6	RIGGING HARDWARE	3-36
3-6.1	Shackles	3-36
3-6.2	Turnbuckles	3-37
3-6.3	Hooks	3-38
3-6.4	End Links and Swivels	3-38
3-6.5	Eye Bolts	3-39
3-6.6	Slings	3-39
3-6.7	Purchases	3-41
3-7	LIFTING	3-42
3-7.1	Passing Lift Wire and Chain	3-43
3-7.2	Buoyant Lift Procedures	3-44
3-7.3	Tidal Lift Procedures	3-47
3-7.4	Mechanical Lifts	3-47
3-7.5	Navy Salvage Ship Heavy Lift	3-47

4 REFLOATING STRANDINGS

4-1	INTRODUCTION	4-1
4-2	GROUND REACTION (R)	4-1

4-2.1	Change of Trim Method	4-2
4-2.2	Tons Per Inch Immersion (TPI) Method	4-2
4-2.3	Change in Displacement Method	4-3
4-2.4	Change of Draft Forward Method	4-3
4-2.5	Ground Reaction and Weight Movement	4-3
4-2.6	Neutral Loading Point (NP)	4-4
4-2.7	Tide and Ground Reaction	4-5
4-3	FREEING FORCE (F)	4-6
4-3.1	Determining Freeing Force	4-6
4-4	REFLOATING OPERATIONS	4-7
4-4.1	Stabilization Phase	4-7
4-4.2	Refloating Phase	4-10
4-4.3	Post-refloating Phase	4-11
4-5	REDUCING GROUND REACTION	4-12
4-5.1	Weight Management	4-12
4-5.2	Inducing or Restoring Buoyancy	4-13
4-5.3	Ground Removal	4-13
4-5.4	Lifting	4-15
4-5.5	Temporary Reductions	4-15
4-6	BEACH GEAR	4-15
4-6.1	Deck Arrangement	4-16
4-6.2	Ground Leg	4-19
4-6.3	Effective Hauling Force	4-28
4-6.4	Heaving Operation	4-29

5 SINKINGS

5-1	INTRODUCTION	5-1
5-2	PATCHING	5-1
5-2.1	Patch Types and Materials	5-2
5-2.2	Patch, Deck, or Bulkhead Pressure	5-3
5-2.3	Patch Construction	5-4
5-2.4	Patch Preparations	5-10
5-2.5	Measuring Techniques	5-11
5-2.6	Patch Placement	5-11
5-2.7	Patch Fastening	5-13
5-2.8	Steel Patches	5-13

5-2.9	Wooden Patches	5-14
5-2.10	Concrete Patches	5-15
5-2.11	Sealants	5-21
5-2.12	Box Patches	5-21
5-2.13	Built-up Patches	5-21
5-2.14	Marking Patches	5-21
5-3	SHORING	5-22
5-3.1	Shoring Materials	5-22
5-3.2	Compensating Buoyant Shoring	5-22
5-3.3	Shoring Guidelines	5-23
5-3.4	Shore Strength	5-23
5-3.5	Shoring Patches	5-27
5-3.6	Shoring Doors and Hatches	5-28
5-4	DEWATERING	5-28
5-4.1	Pumping	5-28
5-4.2	Pump Types	5-29
5-4.3	ESSM Pumps	5-31
5-4.4	Pumping POL Products	5-31
5-4.5	Pump Requirements	5-32
5-4.6	Dewatering Time	5-32
5-4.7	Water Surface Falling Rate	5-33
5-4.8	Pumping Operations	5-33
5-4.9	Dewatering with Compressed Air	5-34
5-4.10	Compressed Air and Pump Combinations	5-41
5-4.11	Water Displacement	5-41
5-4.12	Pumping Plates	5-42
5-5	COFFERDAMS	5-42
5-5.1	Small Cofferdams	5-42
5-5.2	Partial Cofferdams	5-42
5-5.3	Full Cofferdams	5-43
5-5.4	Cofferdams and Stability	5-43

6 TOWING

6-1	INTRODUCTION	6-1
6-2	ATTACHMENT POINTS	6-1

6-2.1	Emergency Attachment Points	6-2
6-2.2	Padeye Design	6-5
6-3	GENERAL TOWING RIG INFORMATION	6-7
6-3.1	Pendant or Single Leg Rig.....	6-7
6-3.2	Chain Bridle or Double-Leg Rig.....	6-8
6-3.3	Lead Chain and Wire Pendant	6-8
6-3.4	Bridle Chain Specifications	6-10
6-3.5	Connecting Hardware	6-10
6-3.6	Synthetic Line	6-11
6-3.7	Backup Towing System	6-11
6-4	ANCHORING	6-12
6-5	TOWING BRIDLE CHECKOFF LIST.....	6-12

7 USEFUL INFORMATION

7-1	INTRODUCTION	7-1
7-2	WEIGHTS AND MEASURES	7-1
7-3	MISCELLANEOUS FORMULAS	7-14
7-4	MATERIAL PROPERTIES.....	7-26
7-5	SALVAGE MACHINERY & EQUIPMENT.....	7-44
7-6	HELICOPTERS.....	7-59
7-7	MISCELLANEOUS INFORMATION	7-60
7-7.1	Wind Force	7-60
7-7.2	Current Force.....	7-60
7-7.3	Catenary Calculations	7-62
7-8	SALVAGE SURVEY	7-68

INDEX

INITIAL ACTIONS FOLLOWING A CASUALTY

1

1-1 INTRODUCTION

A casualty may suffer structural damage and free communication between the ship and the sea. Bunkers or cargo can discharge and pollute the environment. Fires may occur; flooding may cause sinking. The salvor must take immediate action to stop pollution, fight fires and restore the watertight envelope. The situation determines the priority of action. The publications listed in this chapter detail corrective procedures.

Unless there is potential for immediately losing the stranded ship by fire or sinking, the salvor's initial goal should be to contain and stop environmental pollution. However, do not commit all time and resources to protect the environment until it is certain the damaged ship will remain afloat. Salvage and removal of the pollution source is a good means of pollution control.

Survey data is used to form the salvage plan that guides subsequent actions.

1-2 POLLUTION CONTROL AND CLEANUP

Refs: *ESSM CAT; SALMAN VOL 1, VOL 2, VOL 6*

The Navy is responsible for immediately reporting and for cleaning up all Navy oil and hazardous substance (OHS) spills, including spills incident to Navy Salvage operations. Reports must be made to cognizant federal and state authorities in US waters and to designated authorities in foreign territorial waters. Pre-designated Navy-On-Scene Coordinators (NOSCs) have been assigned on a regional basis worldwide to coordinate spill reporting and response. Navy salvors should initiate dialog with the cognizant NOSC as early as possible in the salvage planning process to ensure compliance with environmental regulations and Navy environmental policy. Call SUPSALV at (202) 781-1731 for a current list of NOSC points of contact. For spills in US waters, if the NOSC cannot be immediately contacted, Navy salvors must immediately report spills to the National Response

Center (NRC) at (800) 424-8802 or (202) 267-2675.

Upon request, the NOSC may arrange for salvage site pre-staging of SUPSALV, local Navy, or commercial spill response assets as appropriate. Navy salvors may directly request SUPSALV ESSM spill response assets, such as the "Salvage Support Skimmer System" packaged in a single 8' x 8' x 20' shipping container, or more extensive ESSM spill response assets with contractor operators, as required.

Navy salvors must be aware that there is a National Response System in force for spills in US waters, with rigidly enforced reporting and response requirements. Pre-designated Federal On-Scene Coordinators (FOSCs) have been assigned on a regional basis, by the US Coast Guard in coastal waters and by the Environmental Protection Agency (EPA) in inland waters. The NRC will mobilize the appropriate FOSC following the required spill report. FOSCs have broad authorities and responsibilities under the law to ensure public safety and environmental protection when OHS spills (including Navy spills) occur. The FOSC has the authority to assume control of an ongoing salvage operation when in his/her sole judgment the actions taken to date do not adequately protect the public and/or the environment. Navy salvors should rely on the NOSC for coordination with the FOSC, and for coordination with designated authorities in foreign waters in which similar but highly variable requirements apply

NOSCs and FOSCs should also be considered valuable resources for coordinating the mobilization of environmental, health and safety, and other technical OHS specialists to assist Navy salvors in the event of salvage operations involving significant OHS incidents. The resources listed in 1-2.1, 1-2.2 and Table 1-1 below are available via the NOSC/FOSC or as indicated.

1-2.1 Pollution Support Systems. In the event of actual or potential spills incident to Navy salvage operations, spill response equipment and personnel are available from a number of commercial and Navy sources. Mobilization should be coordinated via the NOSC or SUPSALV. Local Navy facility response equipment including harbor boom, skimmers, and related systems may be

available if the salvage operation is to be conducted near a Navy facility. Local spill contractor resources may also be available and cost effective for minor responses.

Navy-owned, offshore and salvage-related oil spill response equipment with or without contractor operators is available, on a cost-reimbursable basis via the SUPSALV Emergency Ship Salvage Material (ESSM) system. Offshore oil skimmers, booms with mooring systems, POL pumps, hot tap systems, oil storage bladders, and ancillary support systems are available round-the-clock to the NOSC and/or the cognizant fleet salvage commander, from ESSM bases in Williamsburg, VA; Port Hueneme, CA; Anchorage, AK; and Pearl Harbor, HI. Spill response equipment available at ESSM complexes in Singapore; Sasebo, Japan; Livorno, Italy; and Bahrain is currently limited to POL pumps. Check with SUPSALV or the ESSM website at www.essmnavy.net for updates. The web site provides salvage and pollution equipment inventories by location, equipment descriptions, and other useful information.

Hazardous substance (HS) response equipment is not stocked in the ESSM system, but the ESSM contractor can be tasked to provide HS response equipment and specialist personnel, by sub-contract or otherwise, to support Navy salvage operations as required.

1-2.2 Oil and Hazardous Substance Technical Support. OHS technical support systems include the following:

- **CHRIS** - The U.S. Coast Guard's **C**hemical **H**azards **R**esponse **I**nformation **S**ystem includes a manual of pollutant characteristics, potential hazards and cleanup procedures; a hazard assessment computer system; and an organizational entity at each USCG station. CHRIS is under revision but is available as COM-DTINST 16465.12C on CD-ROM. It is discussed at: www.uscg.mil/hq/gm/mor/articles/chris.

- **CHEMTREC** - The **C**hemical **T**ransportation **E**mergency **C**enter. 24-hour telephone clearinghouse for chemical transportation emergencies at (800) 424-9300. It is a non-government-sponsored center that serves as liaison between the hazardous spill responder and the chemical manufacturer to provide warning and limited guidance to those on scene. View the website at www.chemtrec.org.
- **HMIRS** - DOD's **H**azardous **M**aterials **I**nformation **R**esource **S**ystem, formerly Hazardous Materials Information Systems (HMIS) can be viewed at www.dlis.dla.mil/hmirs. It is a For Official Use Only (FOUO) automated system that is the DOD central repository for Material Safety Data Sheets (MSDS) for the US government.
- **OHMTADS** - The EPA's **O**il and **H**azardous **M**aterials **T**echnical **A**ssistance **D**ata **S**ystem is a database of MSDS-like fact sheets. OHMTADS is no longer updated, but the database still contains useful information if used with the proper attention to the file's warning with respect to the age of data. It is available on various commercial websites ([link: ohmtads](#)).

1-2.3 Directives and Telephone Contacts. Directives listed in Table 6-1, *SAFMAN*

Table 1-1. Data Base and Technical Assistance Telephone Numbers.

Organization/Telephone	Information
NAVSEA SUPSALV Day: (202) 781-1731 DSN 326-1731 Night: (202) 781-3889 DSN 326-3889	ESSM Information and Mobilization, Salvage & Environment Tech Support, NOSC POCs
CHEMTREC 800/424-9300 or (703) 527-3887	Chemical Transportation Emergency Center
DOT HOTLINE 202/366-4488	Hazmat Information Center
EPA HOTLINE www.epa.gov/epahome/hotline	Numerous EPA hotline websites
EPA RCRA/SUPERFUND/EPCRA Call Center (800) 424-9346, or www.epa.gov/epaoswer/hotline	Up-to-date information on several EPA regulations regarding Hazardous Material/Waste management
Navy Environmental Health Center (NEHC) (757) 953-0700, or www.nhrc.navy.mil	Disease Prevention
National Pesticide Information Center (800) 858-7378	Pesticide Hotline

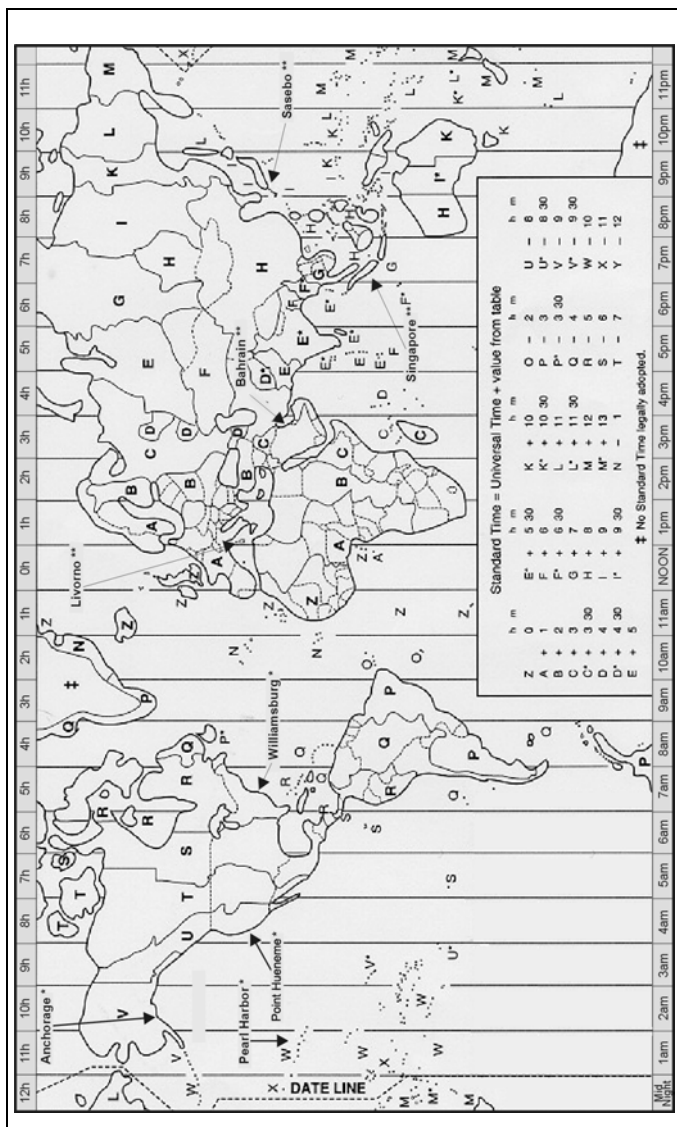

Figure 1-1. ESSM Bases and Time Zones.

1-2.4 Hazardous Materials.

Refs: *SALMAN VOL 2, VOL 6; SAL ENG*

Hazardous materials are natural or synthesized gases, liquids, or solid substances that can cause deterioration of material or injury to living things. **Contact the Navy On-Scene Coordinator (NOSC - see Table 1-1) when a casualty contains cargo known or suspected to be hazardous cargo. The NOSC can assist in determining safety, reporting, and environmental protection requirements.**

1-2.5 Gas Hazards. Closed spaces are not safe until tested for gas hazards. Gases may be explosive, flammable, poisonous and oxygen-deficient. Test for oxygen level, toxic gases, explosiveness and flammability before working in an enclosed space. Continue periodic checks to measure changing conditions. Para 6-5.2, *SAFMAN* discusses spaces subject to gas hazards and suitability for personnel entry and work.

1-2.5.1 Oxygen Deficiency. Enclosed-space oxygen deficiency results from combustion, human respiration, spoiled food fermentation, machinery operation and metal oxidation.

Other gases, combustion by-products and firefighting efforts all dilute oxygen levels. Volatile cargo and gas vapors also leak from ruptured tanks and pipelines, causing oxygen deficiencies.

1-2.5.2 Toxicity. Combustion, organic decomposition and chemical reactions during salvage operations produce gases that are poisonous in small concentrations. Two of these are:

- Carbon monoxide (CO). CO is a gasoline or diesel fuel combustion by-product found near powered machinery. CO is colorless, odorless and usually undetectable by properties common to other gases. Inhalation of large amounts can be lethal.
- Hydrogen sulfide (H₂S). H₂S results from decomposition of sulfur-bearing fuel and other organic material combustion. The highly toxic gas has the odor of **rotten eggs**, paralyzes the sense of smell and is deadly. H₂S is soluble in water, heavier than air, can be transported over vast distances and gathers near the deck. Decaying food and sewage holding tanks and piping

systems generate H₂S. Concentrations of H₂S above 10 ppm are dangerous. A strong **rotten egg** smell is not a measure of H₂S concentration.

Gasoline and other light distillate vapors are toxic in certain concentrations. Rising temperatures increase hydrocarbon vaporization and atmospheric concentration. Inhalation causes drunken behavior, loss of consciousness and death.

1-2.5.3 Gas Under Pressure. A flooded space may contain gases under pressure. Water entry into an unventilated space compresses gases. Opening a space may equalize the pressure violently and rapidly spread toxic or flammable gases.

Always pressure-test the compartment or crack a vent to equalize pressure prior to entering the space.

1-2.5.4 Gas Freeing. Ventilation may not remove all gas hazards from a space. Identify and eliminate the gas source.

- Steaming removes petroleum residues, but carries an electrostatic charge. Check for combustible vapors when introducing steam into a space.
- Exhaust fans are more efficient gas extractors than blowers. Use an extension tube to the bottom of the space to extract heavier-than-air gases. Air entering through high openings replaces the entire atmosphere when suctions are established low in the compartment.
- Dissipate gases into the surrounding atmosphere or collect into appropriate containers. Avoid vented-gas accumulation and contact with ignition sources.
- Pump all liquid from the space, since many dangerous gases are soluble.
- Clean all surfaces.
- Completely replace or replenish the atmosphere.
- Control or disperse all displaced gases.
- Monitor the space continuously.

1-2.5.5 Inert Gas Systems. Installed or portable inert gas systems replace normal tank atmosphere to keep the oxygen content below the combustion level.

Do not relax gas safety precautions after inerting a tank or space.

Inert atmospheres do not support life. When entering inert spaces always use breathing apparatus.

1-2.5.6 Gas Safety. Where suspected gas hazards exist:

- Test initially, extensively and continuously to determine gas hazard type and extent.
- Use breathing apparatus and tended lifelines to enter an enclosed space.
- Provide ventilation to continuously replace the air in spaces where personnel are located.
- Remove ignition sources from areas containing flammable or explosive substances.
- Inspect compartments and tanks for dead spaces and gas stratification.
- Close doors and ports not required for ventilation to prevent movement of gases.
- Seek expert advice if necessary.

1-2.6 Gas Hazard Monitoring Equipment.

Refs: *NSTM* Chap 079

Use only approved test equipment for gas hazard testing

Table 1-2. Gas Hazard Monitoring Equipment.

Equipment	Hazard
Explosive Meter	Explosive Atmosphere
Oxygen Meter	Oxygen Deficiency
Radiation Detector	Radiation
Draeger Tubes	Organic & Inorganic Vapors & Gases
Photoionization Detector (H-NU)	Organic & Inorganic Vapors & Gases
Organic Vapor Analyzer	Organic Vapors & Gases

1-2.6.1 Gas Hazard Protection. Wear protective gear when venting or entering an untested space. Hazardous material protective clothing and respiratory requirements are listed in *SAFMAN*.

1-2.6.2 Gas Testing Sequence. Never gas-test a space without wearing respiratory protection and protective clothing.

Gas-test spaces in the following order:

- Equalize any pressure differentials.
- Test for explosive or combustible gases.
- Test for oxygen sufficiency.
- Test for toxic or anoxic gases.

1-2.7 Explosions. Shipboard explosions result from explosive vapors collected in an enclosed space that are exposed to an ignition source. Common ignition sources in salvage operations are cutting torches, electric arcing, welding and explosive stud guns. Never perform hot work unless the space has been made gas free and steps have been taken to maintain gas free conditions. For underwater salvage work the space must be vented to ensure that the space remains flooded during hot work.

1-2.7.1 Petroleum Cargoes. In sufficient concentration, petroleum vapors are explosive. Fuel cargo and bunkers can be toxic, reactive with other materials and polluting. When handling petroleum products:

- Watch for leaks.
- Avoid spilling petroleum products.
- Clean up spills and residual oil immediately.
- Inert tanks or spaces. Ventilate if unable to inert.
- Cool decks with water to reduce vaporization when temperatures are high.
- Inspect tanks and spaces frequently for vapor concentrations. Conditions may change without warning.
- Ventilate working and berthing spaces.
- Isolate all ignition sources and potential combustible materials.
- Determine the volatility of all petroleum products on board. **More volatile means more dangerous.**

1-2.7.2 Gas and Explosions. Gas in an enclosed space is a potential danger. Following a gas explosion, heat increases rapidly to increase internal pressure. Space boundaries then fail because there are no openings to allow the expanding gases to escape. An explosion in one space may generate enough heat to ignite gas in other spaces. To reduce the chance of explosions:

- Remove ignition sources and hot work near any space not declared gas-free.
- Check gas levels frequently.
- Inert or continuously ventilate cargo and fuel tanks to allow expanding gases to escape.
- Do not allow pressure to build to dangerous levels.

- Isolate spaces containing volatile materials.
- Do not drop or bump compressed gas containers.

1-2.7.3 Explosives. Refer to the *Technical Manual for Use of Explosives in Underwater Salvage*. Treat explosives with caution. To ensure explosive safety:

- Determine what explosive materials are aboard.
- Consider salvaged explosive materials as sensitive.
- Do not let explosives get wet, hot, or undergo changes in pressure. Exposure reduces the explosives' stability. **Instability increases explosive dangers.**
- Isolate or eliminate all ignition sources.
- Allow only qualified people to handle explosives.
- Dispose of or use explosives and ordnance only by following prescribed procedures.
- Consider an explosion's air and water shock wave potential, in addition to its physical and thermal effects.

1-3 FIREFIGHTING

Refs: *SALMAN VOL 1; NSTM Chap 079, NSTM Chap 555*

Gas hazards, explosions and fires may occur either independently or in combination and jeopardize safety during salvage operations. This section discusses shipboard fire types, methods of prevention and firefighting procedures.

1-3.1 Fire Prevention. Prevention is the most positive method of eliminating fire aboard casualties. Take the following precautions:

- Keep work areas clean.
- Eliminate, restrict, or control leaks of vapors, gases and liquids.

- Inert tanks and enclosed spaces that have contained fuels or flammable vapors.
- Ventilate combustible vapors from spaces into the atmosphere. Ventilate to release combustion products from compartments under direct attack by firefighters.
- Properly store flammable materials, such as lubricants, oily rags, paints and solvents.
- Eliminate ignition sources and chemical, thermal and pressure conditions conducive to auto ignition. **Do not allow hot work near untested spaces.**
- Confine to safe areas all sources of shocks, sparks, open flames and static electricity.
- Use and wear spark-proof equipment and clothing. Wrap deck tackle when working on a ship with fire or explosion potential.
- Prepare personnel and maintain firefighting equipment for possible emergencies.

1-3.2 Fire Types. Classify and extinguish shipboard fires as follows:

- Class A. Ordinary combustible materials. Extinguish by quenching and cooling.
- Class B. Flammable liquids, greases, paint and petrochemicals. Extinguish by blanketing and smothering.
- Class C. Electrical system fires. Cut power supply and extinguish by smothering with nonconducting agents.
- Class D. Fires involving a combination of metals and oxidizers. Common in fixed-wing aircraft and helicopter accidents. Difficult to extinguish, but dry chemicals are effective.

1-3.3 Firefighting Procedures.

Ref: *SAFMAN*

When a casualty is burning, assess the situation to formulate a firefighting plan. Take the following actions:

- Close down ventilation systems.
- Shut down machinery.
- Isolate the burning area.
- Direct firefighting forces and equipment according to the contingency plan.
- Safeguard all personnel.
- Keep combustible cargoes cool with a water stream over the deck.
- Request help.
- Avoid abandoning the ship prematurely.

1-3.4 General and Firefighting Protective Equipment.

Wearing proper safety gear and safety protection is the rule on any salvage job. Cease operations until personnel have appropriate protective equipment. Outfit salvage personnel with at least the minimum safety clothing:

- Fire-resistant clothing with flash hoods and gloves. Body protective clothing should be well-ventilated, but not loose.
- Safety shoes with steel toes and non-spark rubber soles
- Hard hats
- Safety goggles
- Gloves when working with rigging, sharp objects and hot materials.

Personnel fighting fires require additional equipment, including:

- Full-face shields
- Proximity suits
- Flotation devices or survival suits capable of supporting the combined weight of the firefighter and his or her protective equipment
- Breathing apparatus.

1-4 RESTORING THE WATERTIGHT ENVELOPE

Refs: *SALMAN VOL 1*; *NSTM* Chap 079

If the situation allows, start watertight envelope restoration immediately. If restoration is delayed, a flooded casualty can be lost through loss of:

- Reserve buoyancy, causing sinking
- Stability, causing capsizing.

Focus initial watertight envelope restoration efforts on stopping and containing the flooding.

- Reduce flooding rate. Do not delay this action to complete the surveys.
- Locate flood water sources during the internal and underwater hull surveys.

Follow up actions include:

- Restoring the watertight envelope. This is discussed in *SALMAN VOL 1* under patching and shoring.
- Calculating flooding effects. *SALMAN VOL 1* discusses combined effects of compartment permeability, free surface, free communication, surface permeability and pocketing, and contains formulas relating to flooding effects.

- Dewatering the ship. *SALMAN VOL 2* discusses dewatering techniques and equipment.

1-4.1 Determining Flooding Amounts. Water quantity flowing through an opening is proportional to the opening's size and depth below the water. To calculate flow:

$$Q = CA \sqrt{H}$$

where:

Q = flow rate

C = 8 to measure Q in ft³/sec
3,600 to measure Q in gallons per minute
825 to measure Q in tons per hour

A = hole area, in square feet

H = depth of the center of the hole below the surface, in feet

1-4.2 Reducing Flood Water Rate. Reduce the water entry rate by:

- Reducing depth of holes. List or trim the ship. Before listing a casualty to stop flooding, refer to *SALMAN VOL 1*. An inappropriate corrective list may make the situation worse.
- Reducing hole size
- Patching holes.

It is important to plug holes immediately, even though some flooding continues. Plugs and wedges help reduce flooding until more permanent patches are installed.

1-4.3 Stopping Flood Water. Stop flooding in the casualty by placing patches internally or externally on the underwater hull. *SALMAN VOL 1* discusses patch construction and installation.

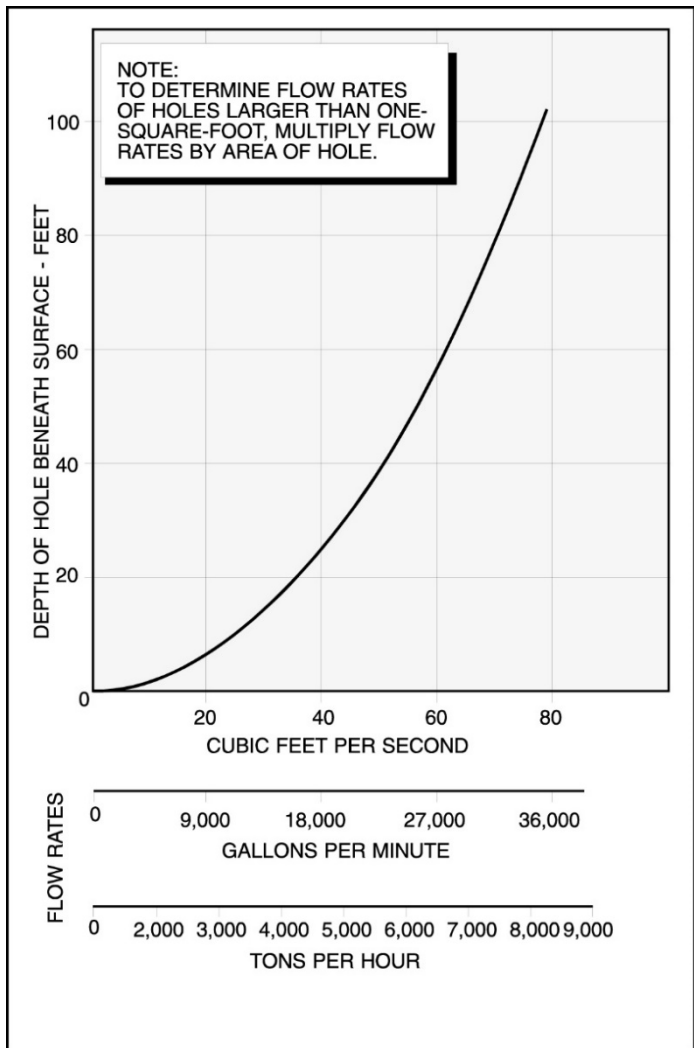

Figure 1-2. Flow Through a One-Square-Foot Hole.

Compressed air pumped into a compartment forces water out above the highest hole and prevents further water intrusion. Repair piping systems and bulkheads to stop spreading of internal liquid.

1-5 SALVAGE SURVEY

Refs: *SALMAN VOL 1; SAL ENG*

Complete the survey forms early to identify hazardous situations and the general conditions of the ship. Section 7-8 contains a complete salvage survey.

1-6 SALVAGE PLAN

Ref: *SALMAN VOL 1; SAL ENG*

The salvage plan details work and resources required for restoring the watertight envelope, repairing damage, dewatering and refloating the ship. The plan should include:

- Information compiled from the internal and underwater surveys
- Engineering calculations of ground reaction, freeing force, stability, strength and hydrographic data
- Pollution efforts
- Results, recommendations and actions from the safety survey
- Annexes.

Supporting annexes or mini-plans schedule work and resources to complete the salvage operation. Detailed annex plans should include:

- Restoring watertight envelope
- Damage repair

- Dewatering by pumping, compressed air and gravity methods
- Reducing ground reaction
- Pulling system rigging
- Pulling sequence
- Extraction route.

THIS PAGE INTENTIONALLY LEFT BLANK

2-1 INTRODUCTION

Ship calculations made in the field during salvage operations are not as precise as calculations made in a design office. Approximations and assumptions based on the best information obtainable are made at the scene.

This chapter briefly addresses naval architecture relative to geometry, stability and strength of intact ships. This chapter is ready reference for:

- Determining hull volume
- Locating naval architecture information
- Determining centers, their heights and related stability measurements
- Making quick stability and weight movement calculations
- Checking the ship's strength.

2-2 COEFFICIENTS OF FORM

Refs: *SALMAN, VOL 1; SAL ENG*

Coefficients of form multiplied by appropriate principal dimensions give hull areas and volumes.

Coefficients of form formulae are found in *SALMAN, VOL 1*. They are:

- Block Coefficient (C_B) =
$$\frac{V}{L \times B \times T}$$

- Midships Coefficient (C_M) =
$$\frac{A_M}{B \times T}$$

Table 2-1. Sample Coefficients of Form

Type Ship	Block Coefficient C_B	Midship Coefficient C_M	Waterplane Coefficient C_{WP}
CV-59	0.578	0.984	0.729
CVN-68	0.624	0.991	0.766
BB-61	0.594	1.000	0.694
CGN-38	0.510	0.810	0.780
CG-47	0.461	0.823	0.724
DD-963	0.510	0.850	0.760
DDG-51	0.519	0.830	0.789
FFG-7	0.470	0.770	0.750
ARS-50	0.542	0.908	0.791
General Cargo (slow-speed)	0.800	0.992	0.880
General Cargo (medium-speed)	0.700	0.980	0.810
General Cargo (high-speed)	0.576	0.972	0.695
Tanker (35,000-ton DWT)	0.757	0.978	0.845
Large Tanker (76,000-ton DWT)	0.802	0.997	0.874
VLCC (250,000-ton DWT)	0.842	0.996	0.916
Container Ship	0.600	0.970	0.740
RO/RO	0.568	0.972	0.671
Ore Carrier	0.808	0.995	0.883
Harbor Tug	0.585	0.892	0.800

- Waterplane Coefficient (C_{wp}) = $\frac{A_{WP}}{L \times B}$.
- Prismatic Coefficient (C_p) = $\frac{V}{A_M \times L}$

U.S. Navy ship coefficients of form are available from NAVSEA, Code O5H.

$$\text{Displacement Volume (V)} = C_B \times L \times B \times T$$

$$\begin{aligned} \text{Displacement } (\Delta) &= V/35 \text{ (saltwater) in long tons} \\ &= V/36 \text{ (freshwater) in long tons} \end{aligned}$$

$$\text{Midships Section Area} = C_M \times B \times T \text{ in square feet}$$

$$\text{Waterplane Area} = C_{WP} \times L \times B \text{ in square feet}$$

$$\text{Tons per Inch Immersion (TPI)} = \text{AWP}/420 \text{ where AWP is in ft}^2$$

2-3 INFORMATION SOURCES

Refs: *SALMAN, VOL 1*

Gather information for salvage calculations from these sources:

Military Vessels

- Curves of Form. Also called displacement and other curves, or hydrostatic curves. Direct reading gives:
 - Total displacement
 - Center of buoyancy longitudinal position and height
 - Longitudinal center of flotation
 - Tons per inch immersion
 - Height of the transverse metacenter

- Moment to change trim one inch.
- Inclining experiment-shows G for a given condition of loading and establishes GM
- Stability and loading data book
- Damage control book
- Liquid loading diagram
- Flooding effect diagram-useful in watertight boundary location (color coding determines whether ballasting or dewatering a compartment is good or bad for stability).
- Draft diagrams [may not be accurate if the ship is excessively trimmed]
- Damage control plates
- Tables and drawings
- Tank sounding tables/curves
- Compartment areas and volumes
- Booklet of general plans
- Deadweight scale
- Capacity plan
- Trim and stability booklet
- Structural plans
- Lines and Offsets Plan
- Offset tables
- Bonjean curves

2-4 DETERMINING CENTERS, HEIGHTS and OTHER STABILITY MEASUREMENTS

Refs: *SALMAN, VOL 1; SAL ENG; NSTM Chap 096*

Determine centers for the forces that affect the ship as soon as possible for a rapid and rough salvage solution.

Descriptions and formulas relating to most centers are discussed in this section.

2-4.1 Center of Gravity (G). *G* is a fixed position or point determined solely by weight distribution within the ship. Weight acts vertically downward through *G*. *G* moves with weight changes.

2-4.1.1 Height of G (KG). *KG* is the height of the center of gravity, in feet, above the keel. Calculate *KG* by:

$$KG = \frac{\text{sum of the moments of weight}}{\text{total weight}}$$

or

$$KG = \frac{(Kg_1)(W_1) + (Kg_2)(W_2) + (Kg_n)(W_n)}{W_1 + W_2 \dots + W_n}$$

An example of calculating *KG* is found in *SALMAN VOL 1*.

***KG* is about six-tenths of the distance between the keel and main deck in most ships.**

2-4.1.2 Longitudinal Position of G (LCG). *LCG* is measured in feet from either the forward or aft perpendicular or the mid- ships section. Determine *LCG* by

$$\text{Distance of } LCG \text{ from } FP = \frac{\text{sum of the moments of weight}}{\text{total weight}}$$

An example of determining *LCG* is found in *SALMAN, VOL 1*.

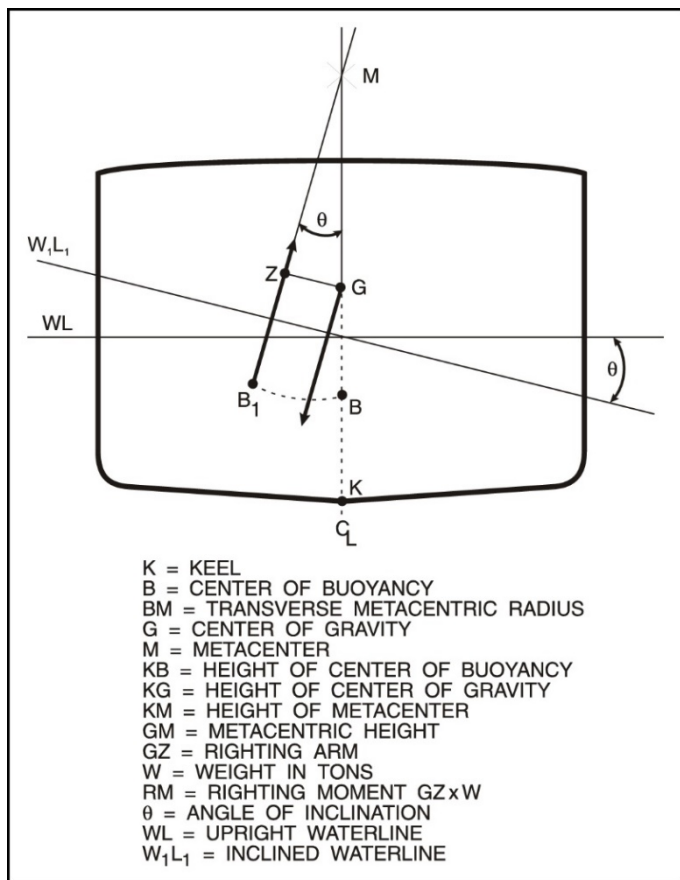

Figure 2-1. Centers, Heights and Righting Arm.

2-4.1.3 Transverse Position of G (TCG). TCG is assumed to be on the centerline unless there is an off center weight removal or addition. SALMAN, VOL 1 discusses transfer movement of G.

2-4.2 Center of Buoyancy (B). B is the geometric center of the submerged hull. The force of buoyancy acts vertically upward, normally through G. When G and B are not vertically in line, the upward force of B tends to rotate or list the ship.

The height of center of buoyancy (KB) depends upon the shape of the ship. Approximate KB by:

$$KB = (\text{Mean Draft}) (.55) \text{ (for most ships)}$$

$$KB = (\text{Mean Draft}) (0.5) \text{ for rectangular barge.}$$

2-4.3 Metacenter (M). M establishes the metacentric height and is a principal indicator of stability

2-4.3.1 Transverse Metacentric Radius (BM). BM is the distance between B and M , measured in feet. BM is the moment of inertia around the longitudinal axis of the waterplane at which the ship is floating, divided by the displacement volume.

$$BM = \frac{I}{\nabla}$$

2-4.3.2 Determining the Height of the Metacenter (KM). KM is the distance between the keel and the metacenter, measured in feet. Determine KM by:

$$KM = KB + BM$$

2-4.3.3 Determining the Metacentric Height (GM). GM is the distance, in feet, between G and M and is a principal indicator of stability. Negative GM indicates the ship is unstable. A neutrally stable ship is a very dangerous situation.

Determine metacentric height by:

$$GM = KM - KG$$

or

$$GM = KB + BM - KG$$

2-4.4 Righting Arm (GZ). GZ is the distance in feet between two parallel lines of force passing through the centers of gravity and buoyancy.

$$GZ = GM \sin \theta$$

where:

$\sin \theta =$ the Sine of the angle of inclination

An increase in righting arm length indicates that the ship is becoming more stable.

When angles of heel greater than 10° to 15° degrees are encountered, the righting arm should be determined from the cross curves of stability. Refer to *SALMAN, VOL 1*.

2-4.5 Righting Moment (RM). *RM* is the product of the righting arm and the ship's displacement. The size of the righting moment at any displacement and angle of inclination is a measure of the ship's ability to return to an upright position.

Determine righting moment by:

$$RM = (W)(GZ)$$

The righting moment is directly proportional to the length of the righting arm. An increase in righting moment indicates that the ship is becoming more stable.

2-4.6 Trim. Trim is fore-and-aft inclination and is measured as the difference between the drafts at the forward and after perpendiculars. **Excessive trim is 1 percent or more of the length of the ship.**

2-4.6.1 Trimming Moment. A moment exerted by weight acting about the center of flotation (*CF*) that causes the ship to rotate around *CF*.

2-4.6.2 Moment to Change Trim One Inch (MT1). The trimming moment required to change trim by one inch. Obtained directly from the curves of form or calculated by:

$$MT1 = \frac{(GM_L)(W)}{12L}$$

where:

GM_L = longitudinal metacentric height

W = displacement

L = length between perpendiculars

Or, for an approximate calculation:

$$MT1 = \frac{(GM_L)(W)}{12L}$$

where:

BM_L = longitudinal metacentric radius

2-5 STABILITY

Refs: *SALMAN, VOL 1; SAL ENG; NSTM Chap 096*

2-5.1 Stability Aground. A ship hard aground may be unstable because the ground reaction causes a virtual rise in G . The ground reaction acts like the removal of a weight equal to the ground reaction force at the keel. However, the cradle effect of the ground tends to support the ship (as in a drydock) and deters listing or capsizing.

2-5.2 Free Surface. A free surface of a liquid in a partially flooded compartment maintains a level plane despite the ship's rolling. This causes the liquid to flow to the low side when the ship heels. Stability is adversely affected because the free surface effect is always negative and GM is reduced. The effective or virtual rise in the center of gravity (free surface effect) is:

$$GG_1 = \frac{i}{V}$$

where:

GG_1 = virtual rise in the center of gravity

i = moment of the inertia of the tank or compartment with the free surface; for a rectangular compartment with b (width) and l (length):

$$i = \frac{(b^3)(l)}{12}$$

V = displacement volume of the ship, NOT the volume of the tank with the free surface

Pressing up or emptying partially filled ballast and fuel tanks will reduce free surface effect.

2-5.3 Pocketing. Pocketing occurs when the ship rolls and liquid moves to expose the decks and cover the overhead. This causes a free surface reduction and a corresponding reduction in loss of G . Free surface effect may be reduced by as much as 25 percent.

No reductions in free surface should be made if there is any doubt that pocketing is occurring.

2-5.4 Free Communication. Free communication effects in off center compartments always result in loss of stability.

A partially flooded, non-centerline space open to the sea introduces the effects of both off-center weight and free surface. This creates a virtual rise in the center of gravity, in addition to that caused by free surface.

Calculate the virtual rise of G by:

$$GG_1 = \frac{(a)(y^2)}{V}$$

where:

GG_1 = virtual rise of the center of gravity due to free communication with the sea

a = surface area of the flooded compartment

y = distance from the centerline of the ship to the center of gravity of the flooded compartment

Note:

There is no free communication effect in a flooded centerline compartment because $y = 0$.

2-5.5 Stability and Tides. If the stranding occurred at high tide, falling tide will result in a loss of net buoyancy and an increase in ground reaction. If the normal range of stability has not been greatly reduced, and the grounding is on a relatively flat bottom (i.e., not a pinnacle) the stranded ship will not capsize while aground.

Conversely, a rising tide will reduce ground reaction and could increase the drafts to a point where the ship is lively. If stability has been significantly reduced because of ground reaction location, free surface and free communication, then the ship could be in danger of capsizing.

Consider ballasting down to increase the ground reaction until the plan calls for deballasting during high tide. Assess the effect of weight addition on stability, ground reaction, and hull strength.

2-5.6 Refloated Ship Stability. Refloated ship stability can deteriorate if conditions change the ship's normal afloat stability. Prior to refloating, calculate the effect of these changes. Causes of deterioration of afloat stability are:

- Addition or movement of topside weight (e.g., Yellow gear)
- Removal of low weight (e.g., fuel oil, ballast, cargo)
- Reduction in reserve buoyancy
- Free surface
- Free communication

Be prepared to pump or ballast to counteract anticipated afloat stability problems before the ship floats free. Waiting until after the ship has been refloated may result in loss of the ship.

2-5.7 Transverse Stability

Ref: *SALMAN, VOL 1; SAL ENG; NSTM Chap 096*

Transverse stability is the measure of a ship's ability to return to an upright position.

When a ship heels over and maintains a list, the ship is in danger of capsizing. The cause of the list should be considered before corrective action is taken.

If the cause is negative metacentric height, the ship could capsize if weights are moved from low in the ship, or shifted from the low side to the high side.

2-6 WEIGHT AND STABILITY

Ref: *SALMAN, VOL 1; SAL ENG; NSTM Chap 096*

Always consider the effect on stability when adding, removing, or relocating weight. Use a weight control log for recording weight changes. **By using this data when calculating a new position of G with each weight change, the salvor maintains an accurate assessment of the position of G.**

2-6.1 Shifting, Adding and Removing Weight

Refs: *SALMAN, VOL 1; SAL ENG; NSTM Chap 096*

Shifting, adding, or removing weight will cause changes summarized in Table 2-2.

Table 2-2. Generalized Weight Movement Effects.

Weight Action	Effect on Stability	Center of Gravity (G)	Center of Buoyancy (B)
Shift up	Decrease	Up	Same
Shift down	Increase	Down	Same
Shift transverse	Decrease	Port/Stbd	To low side
Add at G	Decrease	Same	Up
Add above G	Decrease	Up	Up
Add below G	Increase	Down	Up
Remove at G	Increase	Same	Down
Remove above G	Increase	Down	Down
Remove below G	Decrease	Up	Down

2-6.1.1 Add or Remove Weight at G

Determine weight removal or addition effects at *G* by:

$$\text{Parallel sinkage (or rise) in inches} = \frac{w}{TPI}$$

where:

w = weight added (or removed) in long tons

TPI = tons per inch immersion

2-6.1.2 Weight Movement and G. Moving weight does not change displacement, nor does it cause parallel rise or sinkage. The longitudinal and transverse position and height of *G* can change, depending upon where the weight is moved. Update ship's stability data following weight movement by recalculating the position of *G*:

$$GG_1 = \frac{(Gg)(w)}{W}$$

where:

GG_1 = new distance between the old and new G

Gg = distance the weight was moved (in same units as GG_1)

W = displacement

w = weight moved (in same units as W)

2-6.1.3 Offcenter Weight Addition or Removal and G

Adding or removing offcenter weight causes or reduces inclination and changes the transverse position of G . **G moves in the same direction as the added or removed weight.** Calculate G movement by:

$$GG_1 = \frac{(Gg)(w)}{W \pm w}$$

Inclination results from the moment created between G and B , which in turn is caused by the added or removed weight. Calculate the amount of inclination by:

$$\theta = \tan^{-1} \frac{(w)(Gg)}{(W)(GM)}$$

where:

θ = angle of inclination

\tan^{-1} = a symbol meaning "the angle whose tangent is..."

2-6.1.4 Weight Addition or Removal and KG

When weight is removed or added, the center of gravity will rise or fall. G movement will increase or decrease metacentric height if the location is above or below G .

- Adding weight below G or removing weight above G will generally increase metacentric height and improve stability.
- Adding weight above G or removing weight below G will generally decrease metacentric height and reduce stability.

- Calculate G rise or fall by:

$$KG_1 = \frac{[(KG)(W) \pm (kg)(w)]}{(W \pm w)}$$

where:

KG₁ = new position of the center of gravity

KG = old position of the center of gravity

kg = height of the weight above the keel (in same units as KG)

W = displacement before the weight change

w = weight change (in same units as displacement)

2-7 IMPAIRED STABILITY

Ref: *SALMAN, VOL 1; SAL ENG*

Avoid any degradation of stability. Impaired stability can be caused by:

- Injudicious addition, removal, or shifting of weight
- Flooding
- Free surface effect
- Free communication.

Weight control must be practiced at all times to control the position of G. During the entire salvage operation, maintain the weight control log strictly as discussed in *SALMAN VOL 1*.

Unplanned weight addition, removal, or movement can result in stability degradation by raising G. Maintain control of G at all times.

2-8 STRENGTH OF SHIPS

Ref: *SALMAN, VOL 1; SAL ENG; NSTM Chap 100*

Recognize the symptoms of impaired strength by some of the more common signs such as:

- Buckling of plate and stiffeners
- Heavily indented plates
- Cracking in the plate around other damage
- Fire-damaged plates.

2-8.1 Damaged Strength. When a ship's structure has suffered damage, the ability of the ship to carry design loads is correspondingly reduced.

Temporary repairs restore the strength of the ship to allow the salvage plan to proceed. Weight movement can have an exaggerated effect on conditions that are already taxing the reduced strength of the ship.

2-8.2 Strength Examinations. Make strength examinations both during the initial survey and throughout the salvage operation.

- Examine all principal strength members, including the main deck, stringer plate, sheer strake, bilge strake and keel.
- Evaluate hull strength and the necessity of repairing any structural damage before attempting to refloat. Ships afloat are exposed to stresses created by the variation in buoyancy caused by wave action. In a damaged ship, these actions can quickly lead to catastrophic structural failure.
- Maintain structural continuity of the keel and strength deck. Restore continuity as required.
- Perform strength calculations to verify conditions if loss of hull girder strength or local strength is apparent or suspected or if excessive loads are being applied.

- Program of Ship Salvage Engineering (POSSE) is a computer based program that utilizes files which have been developed for all classes of Naval Vessels to allow real time assessment of Naval Vessels in distress. POSSE can also be used to model non-military vessels to provide similar initial real time assessments. In some cases generic files have been developed for commercial vessels such as oil tankers, bulk carriers, container-ships, etc., to aid in the initial assessment.

2-8.3 Bending Moments

Bending moments are a result of loading in the ship. Excessive bending moments may cause structural failure in hogging and sagging. A complete discussion of longitudinal strength is found in **SALMAN, VOL 1 and SALVENG, VOL 1**.

2-9 TRAPEZOIDAL RULE

The trapezoidal rule substitutes a series of straight lines for a complex curve to allow integration of the curve in a simple tabular format. Conceptually, the trapezoidal rule is the simplest of the numerical integration rules.

A curvilinear shape can be approximated by a series of n trapezoids bounded by $n + 1$ equally spaced ordinates, $y_0, y_1, y_2, y_3, \dots, y_n$, (at stations $x_0, x_1, x_2, x_3, \dots, x_n$) as shown in Figure 2-9. If the station spacing is h , the area ($a_{0,1}$) of the first trapezoid is:

$$a_{0,1} = \frac{y_0 + y_1}{2} h$$

The total area of the shape (A) is approximately equal to the sum of the areas of the trapezoids:

$$\begin{aligned} A &= a_{0,1} + a_{1,2} + a_{2,3} + \dots + a_{n-1,n} \\ &= \frac{y_0 + y_1}{2} h + \frac{y_1 + y_2}{2} h + \frac{y_2 + y_3}{2} h + \dots + \frac{y_{n-1} + y_n}{2} h \\ &= h \left\{ \frac{y_0}{2} + y_1 + y_2 + y_3 + \dots + \frac{y_n}{2} \right\} \end{aligned}$$

This expression is called the *trapezoid rule*, and can be used to calculate areas of any shape bounded by a continuous curve, simply by dividing the shape into a number of equal sections and substituting the ordinate values and the station spacing, or common interval, into the rule.

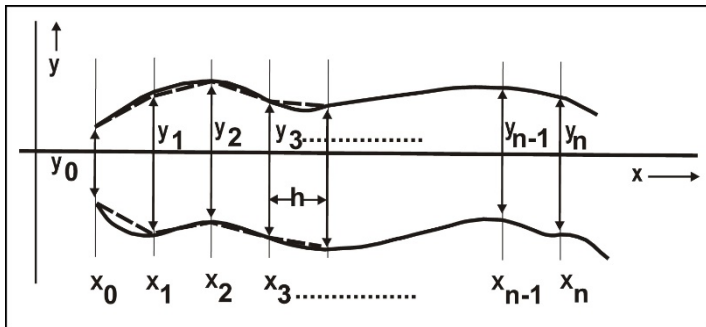

Figure 2-9. Curvilinear Figure Approximated by Series of Trapezoids.

2-10 SIMPSON'S RULES.

The replacement of a complex or small radius curve by a series of straight lines limits the accuracy of calculations, unless a large number of ordinates are used. Integration rules that replace the actual curve with a mathematical curve of higher order are more accurate. Simpson's rules assume that the actual curve can be replaced by a second-order curve (parabola). Figures 2-10 through 2-12 demonstrate the derivations of Simpson's rules.

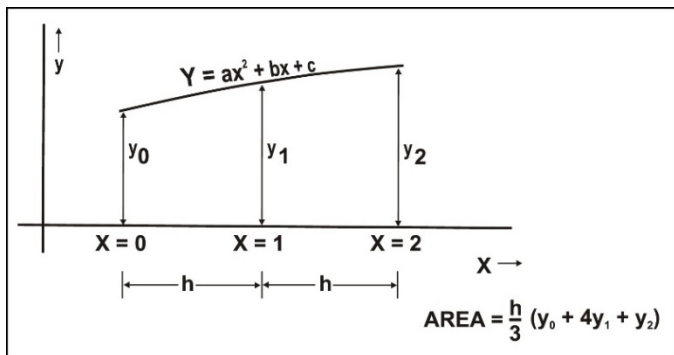

Figure 2-10. Simpson's Three-Ordinate Rule.

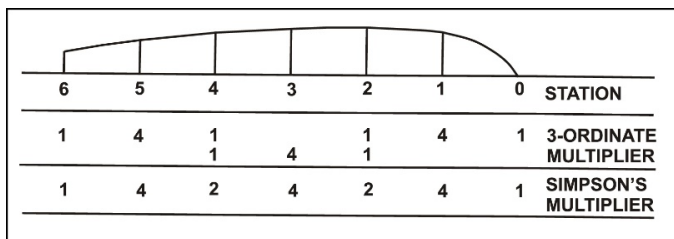

Figure 2-11. Simpson's Multipliers for Long Curve.

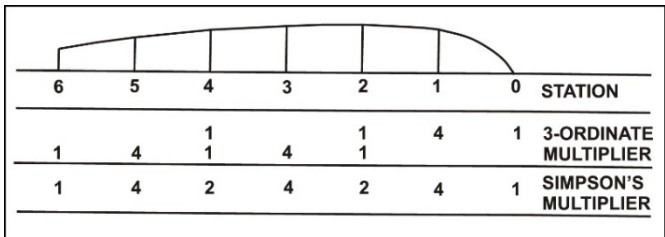

Figure 2-12. Simpson's Multipliers with Half-Space Stations.

3-1 INTRODUCTION

Refs: *SALMAN, VOL 1; SAL ENG*

This chapter discusses rigging strengths and techniques. It is a quick reference for characteristics, working loads, breaking strengths and rigging techniques of lines, wire rope, chain, connectors, beach gear and miscellaneous hardware used during a salvage operation.

3-2 FIBER LINE

Ref: *SAL ENG; NSTM Chap 613*

Fiber line is made from lightweight natural or synthetic material; it handles easily and is impact-resistant. Refer to fiber line up to one inch by diameter and larger lines by circumference (about three times the diameter). Measure length in feet or fathoms.

3-2.1 Fiber Line Property Comparison. The following table indicates comparative properties. It is derived from Table 7-24 of the Salvage Engineers Handbook.

Table 3-1. Line Comparisons

	Manila	Nylon	Kevlar®	Polyster	Polypropylene
Strength per unit of weight (tensile strength/lbs per foot)	30,000	86,500	210,000	66,000	70,000
Water Absorption	≤ 100%	≤ 9%	≤ 1%	≤ 1%	0
Spec Gravity of Fiber	1.5	1.14	1.44	1.38	.91
Abrasion Resistance	Good	Excellent	Excellent	Excellent	Good

Natural Fiber Line. Manila is the superior natural fiber for strength and decay resistance. Natural line fibers creep under load, causing permanent elongation. **Natural fiber rope will part under continuous load.**

3-2.1.1 Synthetic Line. Synthetic fiber lines of nylon, dacron and polypropylene are stronger, more manageable, decay-resistant and easily maintained than manila. Synthetic lines creep less than natural fiber lines and have higher strength because their fibers run the entire length of the line. After removing the load, elastic synthetics shrink to their original length.

Synthetic lines part instantaneously and are dangerous to personnel. Never stand in the line of pull of a synthetic fiber under heavy strain.

Kevlar® lines are in use in oceanographic and offshore work. Although a synthetic fiber, Kevlar® characteristics are similar to wire rope.

Table 3-2. Synthetic Line Construction Characteristics.

Rope Construction	Breaking Strength	Abrasion Resistance	Stretch	Relative Cost	Rotation Under Load
Three Strand	Low	Best	High	Low	Yes
Double Braided	High	Worst	Low	High	No
Plaited	Medium	Medium	Highest	Medium	No
Kevlar®	High	Low	Low	High	No

Table 3-3. Synthetic Line Material Characteristics.

Fiber Type	Strength	Cyclic Fatigue	Bending Fatigue	Abrasion Resistance	Heat Resistance	Creep
Nylon (dry)	VG	VG	G	VG	G	G
Nylon (wet)	G	F	P	P	—	G
Polyester (dry)	VG	VG	G	VG	G	VG
Polyester (wet)	VG	VG	G	E	—	VG
Polypropylene (dry)	F	F	P	P	P	F
Polypropylene (wet)	F	F	P	F	—	F
E=Excellent VG=Very Good G=Good F=Fair P=Poor						

3-2.2 Line Breaking Strength (BS). Line BS is the average load at which a line fails. BS is based on new, dry, clean rope.

Reduce wet nylon line BS by 15 percent.

Consider any line stressed to its BS to be damaged and unsafe.

Table 3-4. Natural and Synthetic Fiber Rope Breaking Strength (lbs).

Rope Circumference, in:	1	1 1/2	2	2 1/2	3	3 1/2	4	4 1/2	5	5 1/2	6	7	8	9	10
Nominal Diameter, in:	5/16	1/2	5/8	13/16	1	1 1/8	1 5/16	1 1/2	1 5/8	1 3/4	2	2 1/4	2 5/8	3	3 1/4
Manilla, 3- & 4-strand twisted, 8-strand plaited	900	2,385	3,960	5,830	8,100	10,800	13,500	16,650	20,200	23,850	27,900	36,900	46,800	57,600	69,300
Nylon, 3-strand twisted, 8-strand plaited	2,300	5,750	9,350	15,300	22,500	29,700	38,750	47,700	58,500	70,200	82,800	113,000	146,000	180,000	225,000
Nylon, double braid	3,060	7,650	13,680	21,150	30,240	40,500	53,100	66,600	81,900	99,000	117,900	159,300	207,000	256,500	289,800
Polyester, 3-strand twisted, 8-strand plaited	2,300	5,750	9,000	14,000	19,800	26,600	33,800	42,100	51,300	61,000	72,000	96,300	123,000	157,000	189,000
Polyester/DURON double braid	3,060	7,650	13,100	20,300	28,300	38,500	49,000	61,200	75,400	90,200	106,000	141,300	180,000	225,000	252,000
Polypropylene monofilament 3-strand twisted, 8-strand plaited	1,710	3,780	5,580	8,910	12,600	16,500	21,200	26,700	32,400	38,700	46,800	62,100	81,000	103,000	123,000
Polypropylene multifilament 3-strand twisted, 8-strand plaited	1,560	3,440	5,080	8,110	11,470	15,020	19,290	24,300	29,480	35,220	45,590	56,510	73,710	93,730	111,930
Polypropylene multifilament double braid	-	-	-	-	-	24,750	31,680	39,420	47,880	57,150	67,140	89,280	114,300	140,400	169,200
Polypropylene monofilament 12-strand single braid	-	-	-	-	-	-	-	-	40,230	47,880	56,160	74,430	94,500	117,000	143,100
Polyethylene 3-strand twisted, 8-strand plaited	1,560	3,440	5,800	8,110	11,470	15,020	19,290	24,300	29,480	35,220	45,590	56,510	73,710	93,730	111,930
Kevlar 12-strand single braid	8,400	20,000	32,400	45,000	63,000	83,000	104,000	129,000	156,000	184,000	214,000	282,000	-	-	-
LST MOORING, polyester cover, polypropylene core, 3-strand	-	-	-	-	-	-	-	-	-	54,900	65,700	90,000	108,000	137,700	166,500

Table 3-4. Natural and Synthetic Fiber Rope Breaking Strength (lbs).

Rope Circumference, in:	1	1 1/2	2	2 1/2	3	3 1/2	4	4 1/2	5	5 1/2	6	7	8	9	10
Nominal Diameter, in:	5/16	1/2	5/8	13/16	1	1 1/8	1 5/16	1 1/2	1 5/8	1 3/4	2	2 1/4	2 5/8	3	3 1/4
LST WORKBOAT, polyester/polyethylene cover, polypropylene core, 3-strand	-	-	-	-	-	-	-	-	-	48,600	58,500	75,600	95,400	117,000	144,000
P/D 10, polyester cover, polypropylene core, 3- & 8-strand	1,710	3,960	5,760	9,180	13,100	17,400	21,200	26,700	32,400	38,700	46,800	62,100	81,000	103,000	123,000
P/D 100, polyester/polypropylene cover, polypropylene core, 3- & 8-strand	-	3,780	6,030	-	12,600	18,900	24,300	30,600	37,800	45,000	54,000	64,800	85,100	105,000	132,000
POLY-PLUS, polypropylene/polyester/polyethylene core and single cover	-	4,050	5,760	9,180	13,500	17,370	22,500	28,170	34,470	41,850	50,850	66,600	86,400	109,800	129,600
POLY-CRON, polyester/polyethylene core and double cover	-	-	-	-	12,600	18,900	24,300	30,600	37,800	45,000	54,000	72,000	94,500	117,000	146,700
PRODOK, polyolefin core, polyester jacket each strand, 3-strand	-	-	-	-	-	-	-	-	-	-	49,950	66,150	85,050	108,000	129,150
DURA-PLEX, polyolefin core, polyester jacket each strand, 12-strand	2,340	6,030	10,440	-	22,500	30,150	38,880	48,600	59,400	71,200	84,000	112,500	144,000	180,000	219,600
BLUE STREAK, polypropylene core, polyester jacket each strand, 12-strand	2,160	5,580	9,900	-	20,700	27,900	36,000	45,000	54,900	66,600	78,300	105,000	135,000	171,000	207,000
KEVLAR core, polyester cover, double braid	-	14,400	23,400	34,200	46,800	61,200	77,400	94,500	113,400	133,200	154,800	201,600	252,900	309,600	370,800
POWER BRAID, polypropylene core, nylon cover, double braid	-	6,840	11,700	18,000	25,260	34,200	44,100	55,170	67,500	81,000	95,400	127,800	164,700	204,300	248,400

Table 3-4. Natural and Synthetic Fiber Rope Breaking Strength (lbs).

Rope Circumference, in.:	11	12	13	14	15
Nom Diameter, in.:	3 1/2	4	4 1/4	4 5/8	5
Manila, 3- & 4-strand twisted, 8-strand plaited	81,900	94,500	-	-	-
Nylon, 3-strand twisted, 8-strand plaited	270,000	324,000	376,000	437,000	501,000
Nylon, double braid	345,600	405,900	470,700	539,100	612,000
Polyester, 3-strand twisted, 8-strand plaited	229,000	270,000	314,000	365,000	419,000
Polyester/DURON double braid	302,400	356,400	414,900	477,900	545,400
Polypropylene monofilament 3-strand twisted, 8-strand plaited	146,000	171,000	205,200	238,200	273,600
Polypropylene multifilament 3-strand twisted, 8-strand plaited	132,860	155,610	186,730	216,760	248,980
Polypropylene multifilament double braid	200,700	234,000	270,000	307,800	347,400
Polypropylene monofilament 12-strand single braid	169,200	198,000	-	-	-
Polyethylene 3-strand twisted, 8-strand plaited	132,860	155,610	8,110	11,470	15,020
LST MOORING, polyester cover, polypropylene core, 3-strand	202,500	238,500	-	-	-
LST WORKBOAT, polyester/polyethylene cover, polypropylene core, 3-strand	175,500	207,000	-	-	-
P/D 10, polyester cover, polypropylene core, 3- & 8-strand	146,000	171,000	-	-	-
POLY-PLUS, polypropylene/polyester/polyethylene core and single cover	153,000	180,000	-	-	-
POLY-CRON, polyester/polyethylene core and double cover	-	-	-	-	-
PRODOK, polyolefin core, polyester jacket each strand, 3-strand	153,000	180,000	--	-	-
DURA-PLEX, polyolefin core, polyester jacket each strand, 12-strand	261,000	303,000	-	-	-
BLUE STREAK, polypropylene core, polyester jacket each strand, 12-strand	252,000	297,000	342,000	396,000	450,000
KEVLAR core, polyester cover, double braid	436,500	506,700	581,400	659,700	742,500
POWER BRAID, polypropylene core, nylon cover, double braid	296,100	348,300	-	-	-
NYDAC, polyester core, nylon cover, double braid	261,000	303,000	-	-	-
NYSTRON SPM BRAID, nylon/polyester double braid	379,800	446,400	517,500	592,200	673,200

3-2.3 Line Safe Working Loads (SWL). Line SWL is a percentage of breaking strength. SWL is the BS divided by the safety factor appropriate for the line material and application. Determine SWL by:

$$SWL = \frac{BS}{f}$$

where:

f = safety factor from Para 3-2.4

3-2.4 Line Safety Factor

Ref: *NSTM Chap 613*

Safety factor is the ratio between the fiber rope's breaking strength and the load applied. **Recommended safety factors for all types of fiber rope are:**

- General use - $f = 6$
- **Critical loads - $f = 10$ (personnel, munitions, HAZMAT).**

These values provide ample reserve to cover line age, condition, friction, bending stress and twisting, as well as judgmental errors. **However, sudden stress can cause a line to part even when used within a prescribed safety factor.**

Fiber rope subjected to dynamic loading has a lower SWL. Short ropes see greater dynamic loads than long ones. Dynamic loading is a term used to describe the amount of force generated by a load as it is moved. Frequently these forces can equal several orders of magnitude above the actual weight of the load. Common generators of dynamic loading include surface wave oscillations, currents, and snap loading. It is not uncommon for dynamic forces to reach 8-10 times the actual weight of the load.

3-2.5 Substituting Fiber Line. Do not substitute lines simply on the basis of strength. Small synthetics are vulnerable to

greater proportional loss of strength from small cuts and chafing than are larger fiber lines.

Table 3-5. Substituting Fiber Line.

Manila	Nylon	Dacron	Poly-propylene
3	2¾	2¾	2¾
3¼	2¾	2¾	3
3½	2¾	2¾	3
3¾	3	3	3¼
4	3¼	3¼	3½
4½	3½	3½	4
5	4	4	4½
5½	4½	4½	5
6	4½	5	5½
6½	5	5	5½
7	5½	5½	6
7½	6	6	6½
8	6	6½	7
8½	6½	6½	7½
9	7	7	8
10	7½	8	8½
11	8½	8½	9½
12	9	9	10
<p>NOTES:</p> <ul style="list-style-type: none"> *All sizes are circumference in inches. *All ropes three-strand construction. *Under 3" substitute size for size. 			

3-2.6 Line Bending Radius. Bending radius affects BS. Small bending radii of knots, splices and hitches cause large strength reductions. Bending radius should not be less than three times line circumference.

Table 3-6. Fiber Rope Strength Reductions.

Knot or Termination	Revised BS (% of orig)
Overhand knot	45
Square knot	45
Bowline	60
Clove hitch	60
Short splice	85
Eye splice with thimble	95
Long splice	87
Round turn and two half-hitches	70

Knots under strain tighten as the line elongates and create significant shear forces. When joining synthetics, use splices instead of knots and take extra tucks.

3-3 WIRE ROPE

Refs: *SAFMAN; SALMAN, VOL 1*

Salvors use wire rope for high strength and durability.

3-3.1 Wire Rope Use by Size. Typical wire rope uses are:

- 5/8-inch - Beach gear purchases
- 7/8-inch - Heavy lift purchases
- 1-1/4-inch - Crown and retrieval wires
- 1-5/8-inch - Beach gear ground leg, heavy lift legs, Liverpool bridles, underriders and mooring systems
- 2- and 2-1/4-inch - Towing hawsers
- 2-1/2-inch or larger - Heavy lift.

3-3.2 Wire Rope Properties. Measure wire rope by diameter. Identification is by the number of strands, wires per strand and the type of core. Wire rope types 6x19 and 6x37 are common in salvage. Wire rope core is either fiber or wire. Fiber core is more flexible; wire core is stronger. Wire rope is either bright or galvanized. Galvanized is 10% weaker than nongalvanized wire rope.

3-3.3 Wire Rope Safe Working Load (SWL). General information on wire rope SWL:

- Wire rope SWL in running rigging, $\frac{\text{nominal strength}}{5}$;
- standing rigging, $\frac{\text{nominal strength}}{4}$
- Decrease SWL 50 percent for dynamic loads
- Engineered beach gear wire safety factors are 1.5 to 3.

The SWL for bright, uncoated, or drawn galvanized wire rope may be approximated by:

$$\text{SWL} = \frac{(C^2)(8,000)}{5}$$

where:

SWL = safe working load in pounds

C = circumference of wire = πd

d = diameter

5 = safety factor

Dynamic loading can subject wire to forces 2 or 3 times the normal load. **Increase safety factors 2 to 3 times for wire subjected to dynamic loading.**

3-3.4 Bending Wire Rope. Wire rope that has been run over drums, rollers, or sheaves loses breaking strength because of bending. As the ratio between the sheave and wire rope diameters decreases, the wire rope service life decreases. The sheave diameter must be large enough to provide a safe rope bending radius.

Table 3-7a. Nominal Strength of Wire Ropes (pounds).

	1/2	5/8	3/4	1	1 1/4	1 1/2	1 5/8	1 3/4	2	2 1/4	2 1/2	2 3/4	3	3 1/2
6x7 IPS/FC	20,600	31,800	45,400	79,400	122,000	172,400	-	-	-	-	-	-	-	-
6x19 IPS/FC	21,400	33,400	47,600	83,600	129,200	184,000	214,000	248,000	320,000	400,000	488,000	584,000	685,000	914,000
6x19 IPS/WSC or IWRC	23,000	35,800	51,200	89,800	138,800	197,800	230,000	266,000	344,000	430,000	524,000	628,000	740,000	982,000
6x19 EIPS/WSC or IWRC	26,600	41,200	58,800	103,400	159,800	228,000	264,000	306,000	396,000	494,000	604,000	722,000	850,000	1,128,000
6X19 CRS/IWRC	22,800	35,000	49,600	85,400	129,400	180,500	-	-	-	-	-	-	-	-
6x37 IPS/FC	21,400	33,400	47,600	83,600	129,200	184,000	214,000	248,000	320,000	400,000	488,000	584,000	685,000	914,000
6x37 IPS/WSC or IWRC	26,600	41,200	58,800	103,400	159,800	228,000	264,000	306,000	396,000	494,000	604,000	722,000	850,000	1,128,000
6x37 CRS/IWRC	22,800	35,000	49,600	85,400	129,400	180,500	-	-	-	-	-	-	-	-
6X61 IPS/IWRC	-	-	-	85,600	132,200	189,000	222,000	256,000	330,000	414,000	518,000	610,000	720,000	966,000
6X61 EIPS/IWRC	-	-	-	98,200	152,200	218,000	254,000	292,000	380,000	478,000	584,000	700,000	828,000	1,110,000
8X19 IPS/FC	18,460	28,600	41,000	72,000	111,400	158,800	-	-	-	-	-	-	-	-
6X91 EIPS/IWRC	-	-	-	-	-	-	-	-	362,000	454,000	554,000	666,000	786,000	1,054,000

Table 3-7b. Wire Rope Weights, Lbs/ft.

	1/2	5/8	3/4	1	1 1/4	1 1/2	1 5/8	1 3/4	2	2 1/4	2 1/2	2 3/4	3	3 1/2
6x7 IPS/FC	0.38	0.59	0.84	1.50	2.34	3.38	-	-	-	-	-	-	-	-
6x19 IPS/FC	0.42	0.66	0.95	1.68	2.63	3.78	4.44	5.15	6.72	8.51	10.50	12.70	-	-
6x19 IPS/WSC or IWRC	0.46	0.72	1.04	1.85	2.89	4.16	4.88	5.67	7.39	9.36	11.60	14.00	-	-
6x19 EIPS/WSC or IWRC	0.46	0.72	1.04	1.85	2.89	4.16	4.88	5.67	7.39	9.36	11.60	14.00	-	-
6X19 CRS/IWRC	0.46	0.72	1.04	1.85	2.89	4.16	-	-	-	-	-	-	-	-
6x37 IPS/FC	0.42	0.66	0.95	1.68	2.63	3.78	4.44	5.15	6.72	8.51	10.50	12.70	15.10	-
6x37 IPS/WSC or IWRC	0.46	0.72	1.04	1.85	2.89	4.16	4.88	5.67	7.39	9.36	11.60	14.00	-	-
6x37 CRS/IWRC	0.46	0.72	1.04	1.85	2.89	4.16	-	-	-	-	-	-	-	-
6X61 IPS/IWRC	-	-	-	1.68	2.63	3.78	4.44	5.15	6.77	8.51	10.50	12.70	15.10	20.60
6X61 EIPS/IWRC	-	-	-	1.85	2.89	4.16	4.88	5.67	7.39	9.36	11.60	14.00	16.60	22.70
8X19 IPS/FC	0.39	0.61	0.88	1.57	2.45	3.53	-	-	-	-	-	-	-	-
6X91 EIPS/IWRC	-	-	-	-	-	-	-	-	7.39	9.36	11.60	14.00	16.60	22.70

General guidelines for wire rope over sheaves are:

- Sheave grooves should be sized for the wire rope.
- Small grooves chafe wire rope.
- Large grooves flatten wire rope.

Table 3-8. Sheave and Drum Ratios.

Rope Class	Suggested D/d Ratio	Minimum D/d Ratio
6 x 7	72	42
6 x 19	51	34
6 x 37	39	26

D - Sheave or drum diameter

d - Wire rope nominal diameter

3-3.5 Wire Rope Inspection. Inspect all wire rope after use in accordance with planned maintenance systems and Chpt 613, *NSTM*.

Replace wire rope when any of the following conditions exist:

- Nominal rope diameter reduced by more than allowed by guidance provided in Figure 3-1.
- Six broken wires in one rope lay length, or three broken wires in one strand lay length.
- Lay Length - The distance measured parallel to the axis of the rope (or strand) in which a strand (or wire) makes one complete helical revolution about the core (or center).
- One broken wire within one rope lay length of any end fitting.
- Pitting from corrosion and any type of heat damage

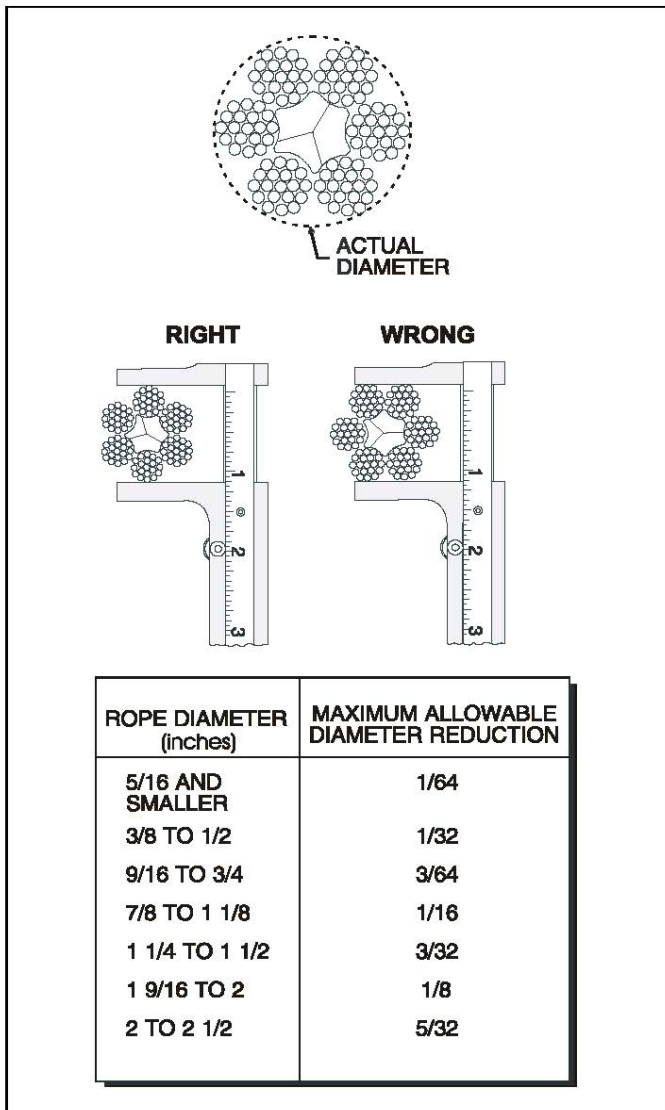

Figure 3-1. Wire Measurement and Reduction Limits.

- Wire rope structure distortion from kinking, crushing or any other cause.

3-3.6 Wire Rope Fittings

Ref: *SAL ENG; NSTM Chap 613*

Wire rope is terminated with swaged, spliced, poured socket, or wire clip end fittings. Poured sockets or mechanical spliced wire rope end connectors can maintain 100 percent strength.

Table 3-9. Wire Rope Fitting Strength.

Fitting	Percent of Original Strength	Remarks
Swaged	90 to 100	Wire core only. For crown and retrieval wires.
Spliced	70 to 90	With or without thimble. Good for slings. Swivel avoids splice spin-out.
Poured Socket	90 to 100	Larger diameter tow wire and ground legs and heavy lift.
Wire Rope Clips	75 to 80	Temporary service. 1-5/8-inch and below.

The most common method used to make an eye or attach a wire rope to a piece of equipment is with cable or Crosby clips of the U-bolt and saddle type or of the double integral saddle and bolt type (known as Safety or Fist Grip). When applied with proper care, thimbles, and according to the following tables and figures, clipped eye terminations will develop 80% of the wire rope strength.

U-bolt clips must have the U-bolt section on the dead or short end of the rope and the saddle on the live or long end of the rope. The wrong application (U-bolt on live instead of dead end) of even one clip can reduce the efficiency of the connection to 40%. See Figure 3-2.

Never use fewer than the number of clips in Tables 3-10A and 3-10B. For maximum holding power the clips should be installed 6 rope diameters apart. Torque nuts to torque recommended in Tables 3-10A or 3-10B. After the rope has been in operation for an hour or so, all bolts should be checked for proper torque since the rope will stretch causing a reduction in diameter. Torque of nuts should also be checked periodically during operation.

Table 3-10A. Installation of Wire Rope Clips.

Rope Diameter (in.)	Minimum No. of Clips	Amount of Rope Turn Back from Thimble (in.)	Torque (ft-lbs) Unlubricated Bolts
1/2	3	11 1/2	65
5/8	3	12	95
3/4	4	18	130
1	5	26	225
1 1/4	6	37	360
1 1/2	7	48	360
1 5/8	7	51	430
1 3/4	7	53	590
2	8	71	750
2 1/4	8	73	750
2 1/2	9	84	750
2 3/4	10	100	750

Table 3-10B. Installation of Double Saddle Clips.

Rope Diameter (in.)	Minimum No. of Clips	Amount of Rope Turn Back from Thimble (in.)	Torque (ft-lbs) Unlubricated Bolts
1/2	3	11	65
5/8	3	13 1/2	130
3/4	3	16	225
1	5	37	225
1 1/4	6	55	360
1 1/2	6	66	500

Double saddle clips (Figure 3-4) are preferable to U-bolt clips since it is impossible to install them incorrectly and they cause less damage to the rope.

STEP 1

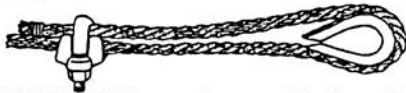

APPLY FIRST CLIP - one base width from dead end of wire rope - U-Bolt over dead end - live end rest in saddle. Tighten nuts evenly to recommended torque.

STEP 2



APPLY SECOND CLIP - nearest loop as possible - U-Bolt over dead end - turn nuts firm but **DO NOT TIGHTEN**.

STEP 3

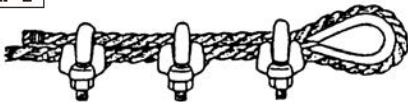

ALL OTHER CLIPS - Space equally between first two.

STEP 4

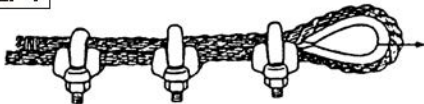

Apply tension and tighten all nuts to recommended torque.

STEP 5

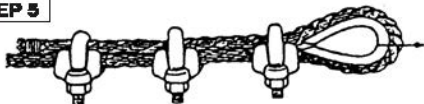

Recheck nut torque after rope has been in operation.

Figure 3-3. Proper Method of Installing Cable Clips.

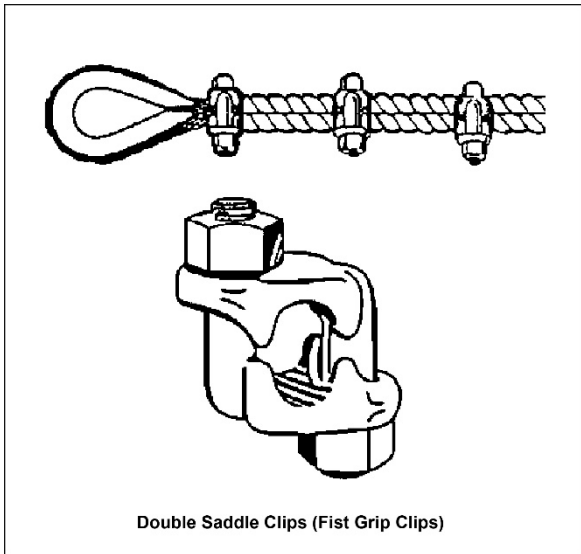

Figure 3-4. Double Saddle Clips (Fist Grip Clips).

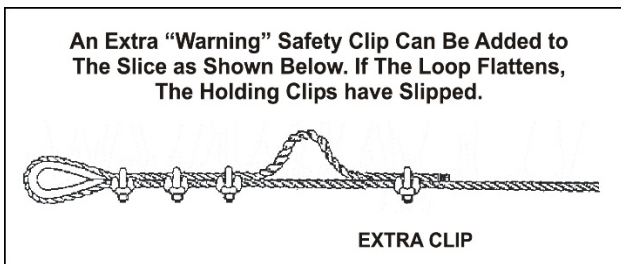

Figure 3-5. Joining Wire Ropes.

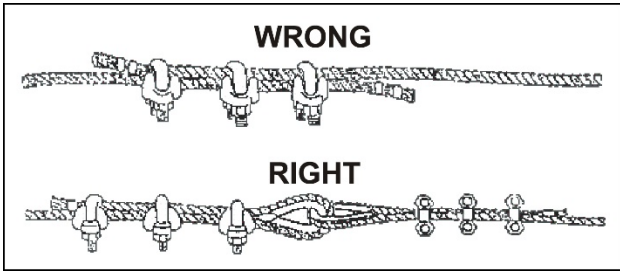

Figure 3-6. Joining Wire Ropes.

3-4 CHAIN

Refs: *SALMAN, VOL 1; NSTM Chap 582*

Chain used in mooring systems and salvage rigging has high strength and durability. Size chain by measuring the bar stock diameter used in its manufacture. Chain lengths are usually 15-fathom (90-foot) shots. Navy standard beach gear and mooring systems use 2-1/4-inch Stud-Link or Di-Lok chain. Most Navy salvage ships carry Di-Lok chain.

3-4.1 Chain Uses. Common uses are:

- Beach gear ground legs
- Towing bridles
- Connecting to attachment points on stranded ships
- Slings
- Parbuckling
- Towing pendant hawsers from stranded ships
- Multi-point moors
- Cutting through hulls.

3-4.2 Chain Construction. Chain construction is identified visually. Treat unidentifiable chain as commercial Grade 1.

3-4.2.1 Di-Lok Chain Characteristics

- Links are larger on one end than on the other.
- Studs are an integral part of the cast link.
- Stronger and more kink-resistant than Stud-Link.
- Preferred for heavy lift legs.
- Suitable for use with small bending radius.

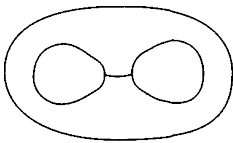

DI-LOK CHAIN IS FORGED WITH THE STUD AS A SOLID PART OF THE LINK. ONE END OF THE LINK IS SLIGHTLY LARGER THAN THE OTHER.

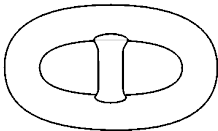

WITH WELDED STUD-LINK CHAIN, THE STUD IS PRESSED IN AND MAY BE WELDED TO LINK ON ONE OR BOTH ENDS



CAST
STUD-LINK



WELDED
STUD-LINK

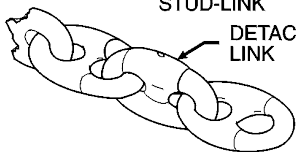

DETACHABLE
LINK

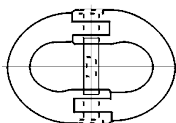

LOK-A-LOY

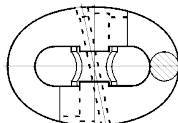

KENTER SHACKLE

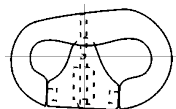

PEAR-SHAPED
DETACHABLE LINK

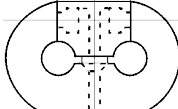

NAVY
DETACHABLE LINK

Figure 3-7. Identifying Chain and Fittings.

3-4.2.2 Stud-Link Chain Characteristics

- Links have separate studs pressed and welded into them.
- Studs prevent the links from turning.

3-4.3 Chain Strength. Break test load is the measurement of a chain's strength.

Table 3-11A. Chain Strength

Characteristics of Navy Stud-Link Chain (MIL-C-24633)				
Size (in)	Number of links per shot	Length of six consecutive links (inches) Nominal	Minimum breaking strength (pounds)	Weight per shot (pounds)
1	267	26	129,000	860
1-1/8	237	29-1/4	161,000	1,080
1-1/4	213	32-1/2	198,000	1,350
1-3/8	193	35-3/4	235,000	1,630
1-1/2	177	39	280,000	1,940
1-5/8	165	42-1/4	325,000	2,240
1-3/4	153	45-1/2	380,000	2,590
1-7/8	143	48-3/4	432,000	2,980
2	135	52	454,000	3,360
2-1/8	125	55-1/4	510,000	3,790
2-1/4	119	58-1/2	570,000	4,250
2-3/8	113	61-3/4	628,000	4,730
2-1/2	107	65	692,000	5,270
2-5/8	101	68-1/4	758,000	5,820
2-3/4	97	71-1/2	826,000	6,410
2-7/8	93	74-3/4	897,000	7,020
3	89	78	970,000	7,650
3-1/4	83	84-1/2	1,124,000	9,010
3-3/8	79	87-3/4	1,204,000	9,730
3-1/2	77	91	1,285,000	10,500
3-5/8	73	94-1/4	1,369,000	11,300
3-3/4	71	97-1/2	1,455,000	12,000
4	67	104	1,632,000	13,700
4-3/4	57	123-1/2	2,550,000	18,900

Table 3-11B. Chain Strength

Characteristics of Di-Lok Chain (MIL-C-19444)				
Type I Standard				
Size (in)	Number of links per shot	Length of six consecutive links (inches) Nominal	Minimum breaking strength (pounds)	Weight per shot (pounds)
1	267	26	129,000	860
1-1/8	237	29-1/4	161,000	1,130
1-1/4	213	32-1/2	198,000	1,400
1-3/8	193	35-3/4	235,000	1,690
1-1/2	177	39	280,000	2,010
1-5/8	165	42-1/4	325,000	2,325
1-3/4	153	45-1/2	380,000	2,695
1-7/8	143	48-3/4	432,000	3,095
2	135	52	439,200	3,490
2-1/8	125	55-1/4	493,200	3,935
2-1/4	119	58-1/2	549,000	4,415
2-3/8	113	61-3/4	607,500	4,915
2-1/2	107	65	669,600	5,475
2-5/8	101	68-1/4	731,700	6,050
2-3/4	97	71-1/2	796,500	6,660
2-7/8	93	74-3/4	868,500	7,295
3	89	78	940,500	7,955
3-1/4	83	84-1/2	1,089,000	9,410
3-1/2	77	91	1,244,800	10,900
3-3/4	71	97-1/2	1,575,000	12,500
4-3/4	57	122-1/2	2,550,000	20,500

Table 3-11B. (Continued). Chain Strength

Characteristics of Di-Lok Chain (MIL-C-19444)				
Type II Heavy Duty				
Size (in)	Number of links per shot	Length of six consecutive links (inches) Nominal	Minimum breaking strength (pounds)	Weight per shot (pounds)
2-3/4	97	71-1/2	882,900	7,000
3	89	78	1,035,000	8,100
3-1/2	77	91	1,530,000	12,000
Type III High Strength				
3/4	359	19-1/2	91,100	550
1	267	26	156,700	1,000
1-1/8	237	29-1/4	195,000	1,270
1-3/8	193	35-3/4	285,500	1,900
1-1/2	177	39	340,200	2,260
1-5/8	165	42-1/4	395,000	2,620

Table 3-11C. Chain Strength

Characteristics of Commercial Stud-Link (ABS)						
Chain Diameter	Length of Five Links	Weight Pounds per 15 Fathoms	Normal Strength Grade 1 Breaking Load	High Strength Grade 2 Breaking Load	Extra-high Strength Grade 3 Breaking Load	Oil Rig Quality ¹ Breaking Load
Inches	Inches	Pounds	Pounds	Pounds	Pounds	Pounds
3/4	16 1/2	480	34000	47600	68000	----
1	22	860	59700	83600	119500	129000
1 1/8	24 3/4	1080	75000	105000	150000	161000
1 1/4	27 1/2	1350	92200	129000	184000	198000
1 3/8	30 1/4	1630	111000	155000	222000	235000
1 1/2	33	1940	131000	183500	262000	280000
1 5/8	35 3/4	2240	153000	214000	306000	325000
1 3/4	38 1/2	2590	176000	247000	352000	380000
1 7/8	41 1/4	2980	201000	281000	402000	432000
2	44	3360	227000	318000	454000	488000
2 1/8	46 3/4	3790	255000	357000	510000	548000
2 1/4	49 1/2	4250	284000	396000	570000	610000
2 3/8	52 1/4	4730	314000	440000	628000	675000
2 1/2	55	5270	346000	484000	692000	744000
2 5/8	57 3/4	5820	379000	530000	758000	813000
2 3/4	60 1/2	6410	413000	578000	826000	885000
2 7/8	63 1/4	7020	449000	628000	897000	965000
3	66	7650	485000	679000	970000	1045000
3 1/4	71 1/2	9010	562000	787000	1124000	1210000
3 1/2	77	10500	643000	900000	1285000	1383100
3 3/4	82 1/2	12000	728000	1019000	1455000	1750000
4	88	13700	816000	1143000	1632000	1996500

¹ Oil rig quality information from commercial vendor.

Table 3-11D. Characteristics of General Purpose Alloy Steel Chain

Chain Size (in.)	Working Load Limits (lbs.)	Weight per 100-ft
	Grade 80	
9/32 (1/4)	3,500	67
5/16	4,500	114
3/8	7,100	144
1/2	12,000	243
5/8	18,100	372
3/4	28,300	581
7/8	34,200	699
1	47,700	996
1 1/4	72,300	1,575

3-4.4 Chain Safety Factor. Chain SWL is about one-fourth of the break test load when applying strain gradually in a straight line.

Bending chain around corners and small radii can significantly lower the breaking strength and SWL. **Chain bending radius should be seven times the diameter of the bar used to manufacture the chain.**

3-4.5 Chain Inspection.

Inspect chain for elongated or cracked links during and after use.

Elongated link check:

- A stretched link will exceed the manufacturer's specified length.
- Hang the link after use, measure its overall length and compare with the standard given in Tables 3-11B, C and D for Milspec chain. **Consider any six links (five links for commercial chain) exceeding the manufacturer's specifications to be stretched.**

Cracked link check:

- Ring each link under strain with a hammer.
- Good links will have a clear, ringing tone.
- Bad links will have a dull, flat tone.

3-4.6 Chain Connecting Hardware

Connecting hardware joins chain sections and attaches system components. Connecting hardware includes:

- Detachable and pear-shaped detachable links
- Chain stoppers
- Shackles
- Plate shackles.

Chain stopper and turnbuckle breaking strength can be as low as 60% of the chain designed breaking strength. Rate chain stoppers at 60% breaking strength of the same size chain unless documentation shows otherwise.

Connector size and breaking strength should be equal to the chain to which they attach.

Shackles are discussed in Paragraph 3-6.

- Personnel working with detachable links must wear eye protection due to the danger of flying lead pellet chips.
- Use only detachable links modified to accept hairpin keepers in towing and salvage operations.
- A complete detachable link tool kit must be on station when working with chain systems.

LOCK WITH MACHINE BOLT SECURED WITH TWO JAM NUTS

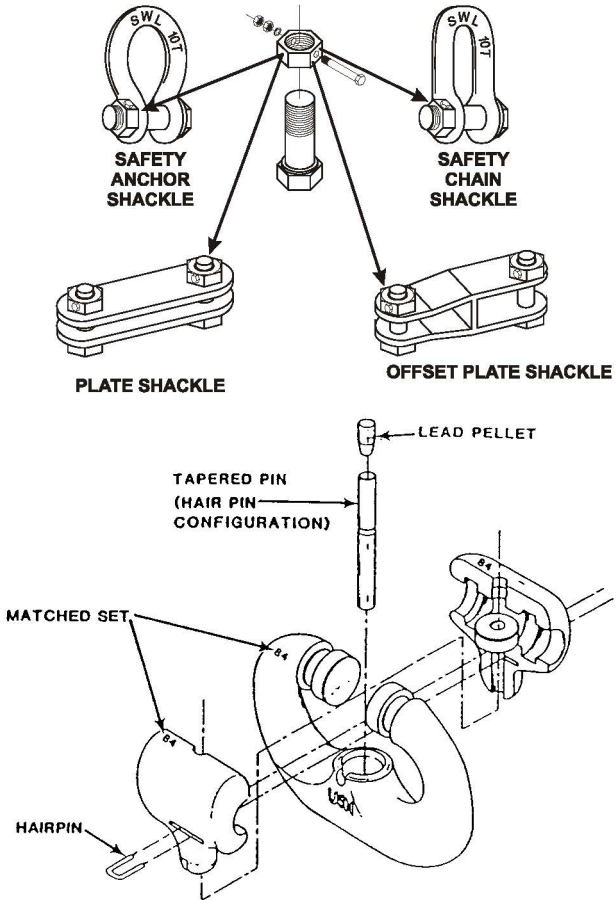

Figure 3-8. Chain Connecting Hardware

3-5 ANCHORS

Refs: *SALMAN, VOL 1; SAL ENG; NSTM Chap 581*

Anchors are the critical components in beach gear ground legs and moorings. This section discusses the efficiency and characteristics of various salvage anchors.

3-5.1 Anchor Types. Drag embedment anchors are the most common in salvage operations.

3-5.2 Anchor Holding Power. Determine approximately with the formula:

$$H = (W)(e)$$

where:

H = holding power in pounds

W = anchor dry weight in pounds

e = anchor efficiency from Table 3-12

Table 3-12. Holding Power for Navy Salvage Anchors.

Type	Weight	Holding Power		Efficiency	
		Sand	Mud	Sand	Mud
NAVMOOR	6,000	166,800	132,000	27.5	22.0
STATO	6,000	120,000	129,000	20.0	21.0
Eells	8,000	58,000	38,000	7.3	4.8
LWT	6,000	83,700	54,400	13.9	9.0
Danforth	6,000	83,700	54,400	13.9	9.0
Stockless	6,000	29,400	15,000	4.9	2.5
Clump				1.0	1.0

Table 3-13. Drag Anchor Comparison.

	Cohesive soils (clays and silts)			Cohesionless soils (sands)		
	Tripping Dig-in	Stability	Holding Power	Tripping Dig-in	Stability	Holding Power
STATO/NAVMOOR	High	Med	High	High	High	High
Eells (with mudplates)	High	Med	Low	High	High	Med
Eells (w/o mudplates)	Low	Med	Low	High	High	Med
LWT	Low	Low	Low	High	Med	Med
Danforth	Med	Low	Med	High	Med	Med
Stockless (fixed fluke)	High	Med	Low	High	High	Low
Stockless (movable fluke)	Low	Med	Low	High	Med	Low

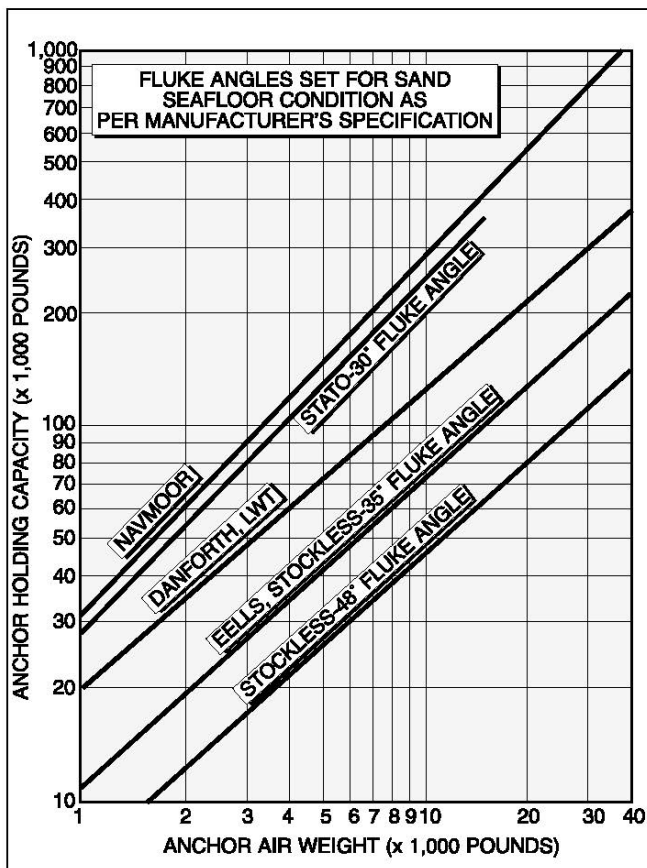

Figure 3-9. Drag Anchor System Holding Capacity in Mud.

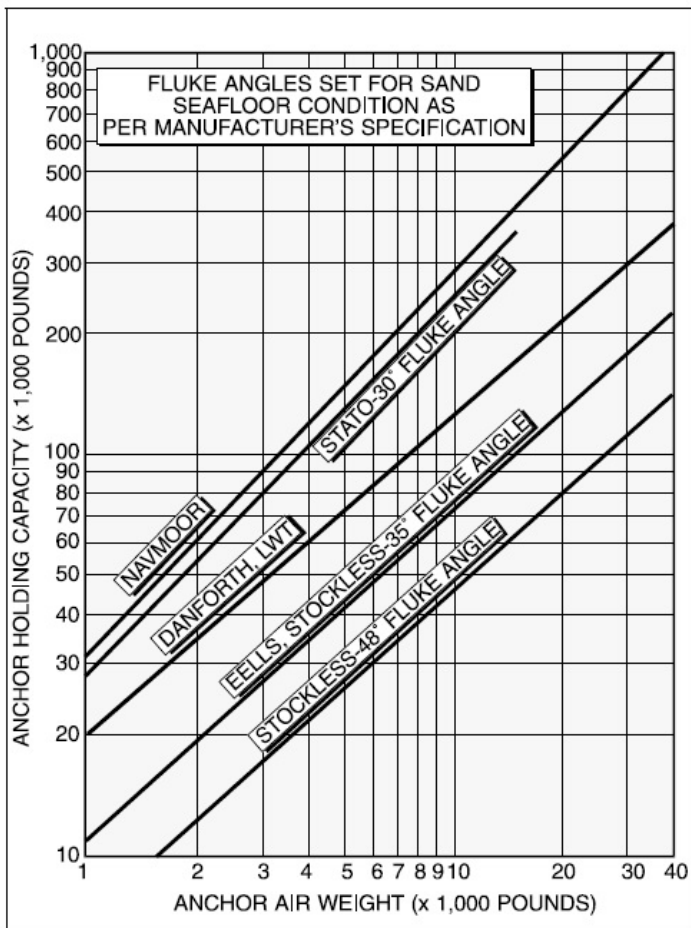

Figure 3-10. Drag Anchor System Holding Capacity in Sand.

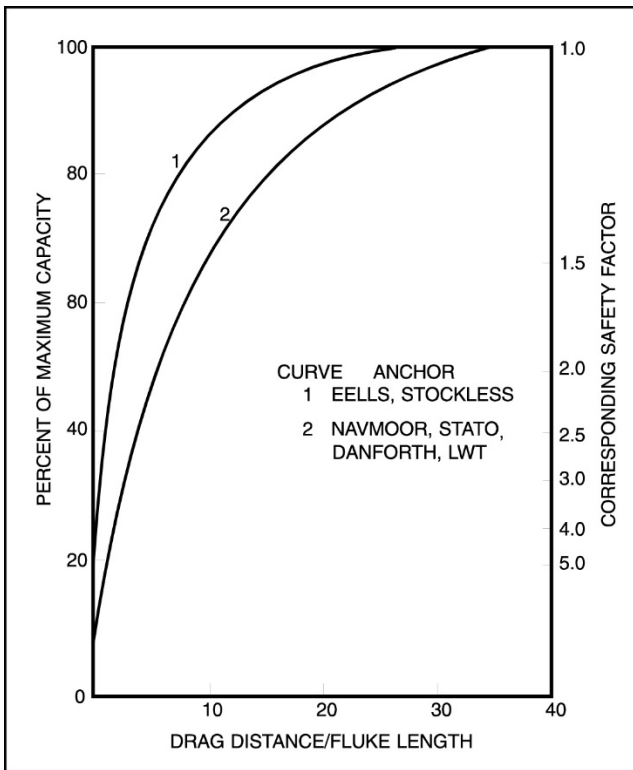

Figure 3-11. Anchor Holding Capacity versus Drag Distance in Mud.

3-6 RIGGING HARDWARE

Ref: *SALMAN, VOL 1; SAL ENG*

This section describes the characteristics and safe working loads for turnbuckles, shackles, hooks, end links, eye bolts, swivels, slings and purchases. All rigging hardware should be in good physical condition. Metal surfaces in contact with fiber or wire rope should be clean and smooth.

3-6.1 Shackles. Shackles are key connectors in salvage systems. Use only safety type shackles that have a bolt and two locking nuts. Shackles are marked with embossed or raised letters showing either Grade A or B. Grade A designates required strength and Grade B high strength. Grade B shackles are preferable because they can have SWLs three times as high as the same size Grade A shackle. Older shackles have no markings and lower SWLs. Calculate older shackle SWLs by the formula:

$$SWL = (2)(D^2)$$

where:

SWL = safe working load in short tons

D = diameter of the bow or side in inches

This formula applies to older shackles. It can be applied to Grade A shackles by doubling calculated SWL for the same size shackles. The resultant SWL will be slightly greater than the SWLs found in Table 3-15.

Safety shackles should be used whenever possible. If only screw pin shackles are available, the **pins should be seized with wire.**

Table 3-15. Safety Shackle SWL.

Size Inches	Recommended Safe Working Load (Maximum) Pounds		Breaking Load (Minimum) Pounds	
	Grade A	- Grade B	Grade A	- Grade B
3/16	520	900	2,600	4,500
1/4	710	2,000	3,550	10,000
5/16	1,060	3,120	5,300	15,600
3/8	1,590	3,800	7,950	19,000
7/16	2,170	5,180	10,850	25,900
1/2	2,830	6,500	14,150	32,500
5/8	4,420	10,000	22,100	50,000
3/4	6,360	13,800	31,800	69,000
7/8	8,650	18,700	43,250	93,500
1	11,310	24,400	56,550	122,000
1-1/8	13,360	28,600	66,800	143,000
1-1/4	16,500	36,000	82,500	180,000
1-3/8	19,800	41,400	99,800	207,000
1-1/2	23,740	48,800	118,700	244,000
1-5/8	27,900	57,400	139,500	287,000
1-3/4	32,320	65,000	161,600	325,000
2	42,220	85,040	211,100	425,200
2-1/4	54,000	—	270,000	—
2-1/2	67,600	121,400	338,000	607,000
3	96,200	150,000	481,000	750,000
3-1/2	131,100	200,000	655,500	1,000,000
4	171,140	260,000	855,700	1,300,000

3-6.2 Turnbuckles. Turnbuckles set up tension between two points. A chain-stopper turnbuckle is attached to the deck pad-eye. Turnbuckles are sized by the threaded area diameter and measured in length by the distance inside the barrel. Calculate SWL by:

$$SWL = 4(D^2)$$

where:

SWL = safe working load in short tons, based on a safety factor of 5 to 1

D = diameter in inches

3-6.3 Hooks. Hooks are about one-fifth as strong as shackles. Measure hook diameter at the shank. A hook is the weakest part of a tackle. Hooks should always be moused.

3-6.4 End Links and Swivels. End links have no stud to allow passing a bending shackle, are 1.25 times the chain size and are the last link in a chain shot. Swivels keep twists out of wire rope and chain that reduce the SWL.

Table 3-16. Connecting Device SWL

Diameter (inches)	End Links	Eye Bolts	Swivels	Hooks	Turn-buckles
1/4	--	500	850	--	400
5/16	2,500	800	1,500	--	700
3/8	3,800	1,200	2,250	--	1,000
7/16	5,100	--	2,900	--	1,250
1/2	6,500	2,200	3,600	--	1,500
5/8	9,300	3,500	5,200	--	2,250
3/4	12,000	5,200	7,200	1,400	3,000
7/8	14,000	7,200	10,000	2,400	4,000
1	15,200	10,000	12,500	3,400	5,000
1-1/8	20,800	12,600	15,200	4,200	5,000
1-1/4	26,400	15,200	18,000	5,000	7,500
1-3/8	30,000	18,300	31,600	6,000	--
1-1/2	34,000	21,400	45,200	8,000	--
1-5/8	--	--	--	9,400	--

NOTES: All SWL in pounds

3-6.5 Eye Bolts. Eye Bolt SWL changes with angular loading.

Table 3-17. Eye Bolt SWL with Angular Loads.

Diameter (inches)	SWL (Pounds) Plain Pattern			SWL (Pounds) Shoulder Pattern		
	30°	45°	90°	30°	45°	90°
1/4	120	80	60	140	100	80
5/16	240	160	120	280	200	160
3/8	420	280	210	490	350	280
7/16	600	400	300	700	500	400
1/2	780	520	390	910	650	520
9/16	900	600	450	1,050	750	600
5/8	1,200	800	600	1,400	1,000	800
3/4	1,800	1,200	900	2,100	1,500	1,200
7/8	2,100	1,400	1,050	2,450	1,750	1,400
1	2,400	1,600	1,200	2,800	2,000	1,600
1-1/8	3,000	2,000	1,500	3,500	2,500	2,000
1-1/4	4,500	3,000	2,250	5,250	3,750	3,000
1-1/2	5,400	3,600	2,700	6,300	4,500	3,600
1-3/4	6,600	4,400	3,300	7,700	5,500	4,400
2	7,800	5,200	3,900	9,100	6,500	5,200

3-6.6 Slings. General considerations for using slings are:

- Spreader bars eliminate crushing the lifted object.
- Each vertical sling leg carries the load divided by the number of parts (sling legs).
- Sling leg tension increases as the angle between the legs increases.
- Multiple-part slings carry greater loads.
- Weight lifted by slings depends upon:
 - Sling material
 - End fitting type
 - Attachment method
 - Sling angular loading.

3-6.6.1 Sling Tension. Sling leg tension increases as the angle of the slings at the hook increases.

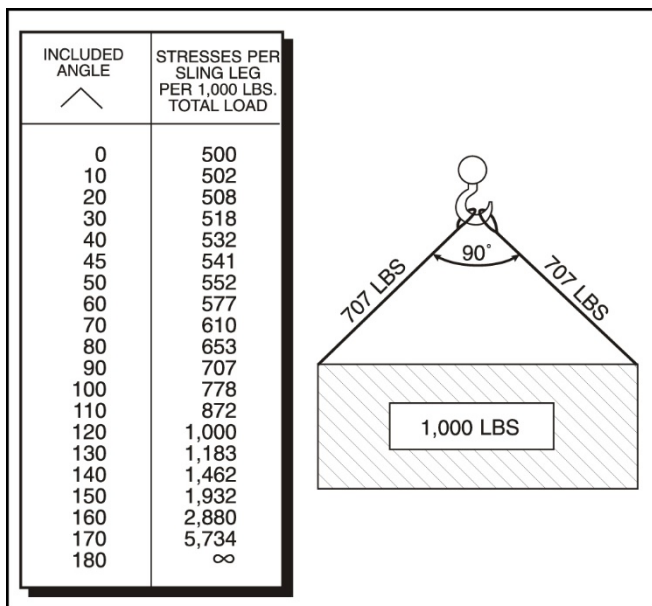

Figure 3-12. Sling Load Tension with Angular Loading.

3-6.6.2 Calculating Multiple Sling SWL. Calculate by:

$$SWL = \frac{(BS) (N) (\sin \Theta)}{F_s}$$

where:

SWL = safe working load

BS = sling material breaking strength

N = number of sling legs

Sin Θ = angle between the load horizontal axis and the sling at the load attachment point

F_s = safety factor

3-6.7 Purchases

Refs: *SALMAN, VOL 1; SAL ENG*

Purchases allow low-powered heaving equipment to develop high forces. They range from small, hand-operated tackle to large, tug-hauled dynamic systems.

3-6.7.1 Purchase Actual Mechanical Advantage (AMA).

Purchase AMA is less than Theoretical Mechanical Advantage (TMA) because of friction in the system. Purchase TMA is the same as the pull ratio of the bitter end to the pull on the traveling block or number of purchase wire parts at the traveling block. Determine AMA by:

$$AMA = \frac{TMA}{1 + (k \times N)}$$

where:

AMA = actual mechanical advantage

TMA = theoretical mechanical advantage

N = number of sheaves in the purchase system. Include all sheaves in the moving, standing and fairlead blocks in the number (N) of sheaves in the purchase system

k = friction factor (Para 3-6.7.2)

3-6.7.2 Purchase Friction. Friction in a purchase is a function of the number and condition of the sheaves and the amount of rope in contact with the sheaves. Determine friction loss by multiplying the friction factor by the number of sheaves in the entire purchase system. Include the friction factor in any AMA calculation. Friction guidelines are:

- Friction factor is 0.10 for sheaves in good condition with the wire bending 180 degrees.
- Friction factor may be reduced to 0.06 for low-friction blocks such as those in heavy lift purchases.

- Friction factor may increase to 0.25 for poorly lubricated or nonstandard blocks.
- AMA calculations account for sheave bearing friction, rope moving over the sheaves and purchase weight.

3-6.7.3 Purchase SWL. Calculate purchase SWL with the formula:

$$SWL = \frac{10 \times TMA \times L}{10 + N}$$

where:

SWL = purchase safe working load in tons

TMA = purchase mechanical advantage

L = purchase line SWL in tons

N = number of sheaves in the system

The above formula makes an allowance for sheave friction in the tackle.

3-6.7.4 Calculating Purchase Pull Required. To calculate the pull to lift a known weight with a purchase:

$$P = \frac{W + (0.1W)(N)}{MA}$$

where:

P = pulling force

W = load weight

N = number of sheaves

MA = purchase mechanical advantage

3-7 LIFTING

Ref: *SALMAN, VOL 1; SAL ENG*

Lifting is done with cranes, pontoons, lift barges and salvage ships and is categorized into three types:

- Buoyant. Volume lift devices attached externally to the sunken ship or onto wires passing under it. Includes collapsible lift bags and rigid steel pontoons.
- Tidal. Craft moored above or alongside the sunken ship lift with the rising tide. Wires are passed under the sunken ship. These craft deballast to gain further lift.
- Mechanical. Salvage ships and cranes lift directly on wires passed under or attached to the sunken ship. Lift is done with heavy purchases.

One or more of the basic lifting methods can be combined with buoyancy recovery, such as dewatering and compressed air, to gain the necessary lifting force. Measure lifting force in short tons. **During combined lifts, buoyancy is recovered before external lifting is applied.**

3-7.1 Passing Lift Wire and Chain

Ref: *SALMAN, VOL 1*

Lift wire and chain are passed by the following methods:

- Direct reeving. Pass wire and chain through existing openings in the sunken ship. Use hawse pipes, stern apertures, holes cut into the hull and natural passages under the keel.
- Sweeping. Haul wire and chain under the keel by tugs or deck power. Soft bottom soils are best for this procedure.
- Lancing. Pull wire and chain through holes formed under the ship with air or water lances.
- Tunneling. Pull wire and chain through holes tunneled under the ship by divers.

- Profile dredging. Cut and excavate lift wire tunnels.
- Drilling. Pull lift wire through pipe string laid by drill rig.

Chain is preferred to wire rope when chafing is expected. Wire will part if chafed.

3-7.2 Buoyant Lift Procedures. Salvage pontoons and inflatable lift bags are buoyant lifting devices attached to the sunken object or lift wires. Air is pumped into the buoyant device to replace the water and to give positive buoyancy. These devices should have three valves:

- Vent valve
- Flood valve to admit water for sinking and to discharge water during blowing
- Relief valve for expanding air to escape as the pontoon rises.

Large pontoons are available commercially.

Parachute-style air bag lift capacities range from 5 to 35 tons. Relief valves are not required on parachute-shaped lift bags because they are open at the bottom. During tows, these bags are more stable than enclosed bags. Enclosed bags tend to distort under tow and become inefficient.

Sling (chain or wire) weight must be subtracted from the pontoon's lift capacity to determine the net lifting force.

When lifting sunken ships from deep water, lift in stages as follows:

- Lift the ship off the bottom.
- Tow it to shallower water and set it back on the bottom.
- Rerig pontoons and repeat.

SALMAN, VOL 1 contains more detail on control pontoons.

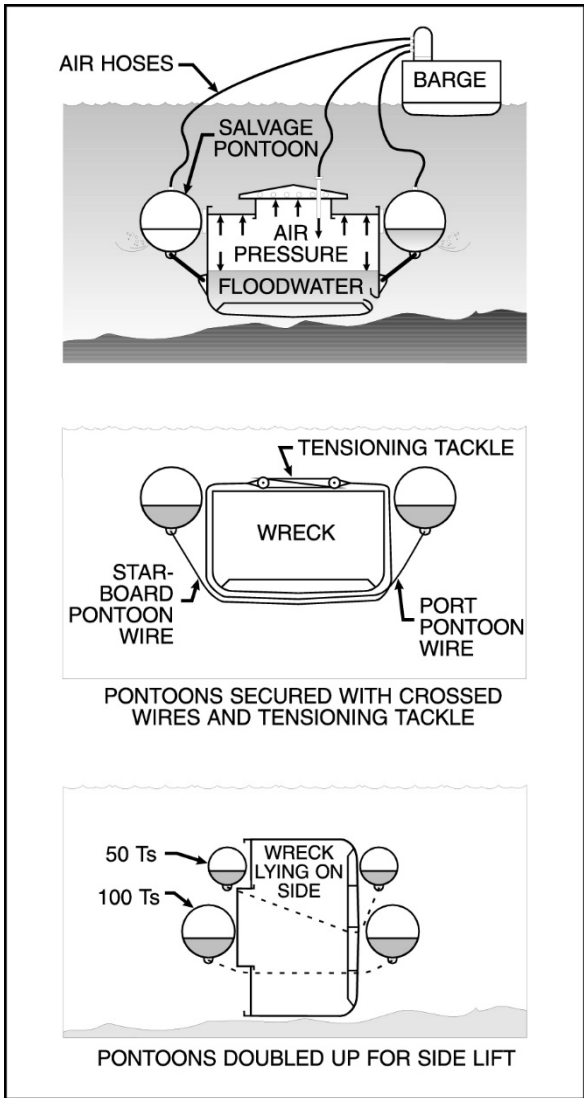
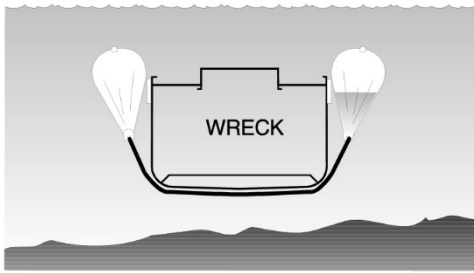
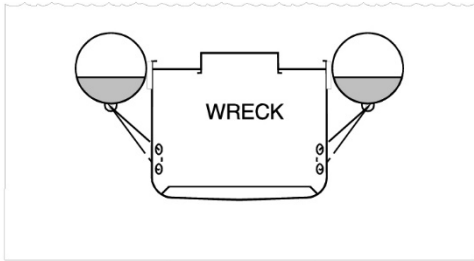

Figure 3-13. Rigging Pontoons and Lift Bags.



LIFT BAG WIRES PASS UNDERNEATH
WRECK. WRECK FREE TO RENDER
BETWEEN THE LIFT BAGS



PONTOONS SECURED TO CHAINS
ROVE THROUGH HOLES CUT IN HULL

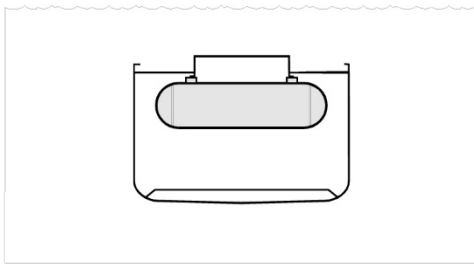

PONTOONS PLACED INSIDE HOLDS

Figure 3-14. Rigging Pontoons and Lift Bags.

3-7.3 Tidal Lift Procedures

Ref: *SALMAN, VOL 1*

Tidal lifting is done by attaching lift craft, salvage ships, or barges to the sunken ship and using the rising tide and deballasting as the lifting force. At high tide, the sunken ship is moved to shallower water and the lift wires rerigged. The process is repeated until the sunken ship is raised by patching and pumping.

Tidal lifts are infrequent because the specialized craft are no longer active and high-lift-capacity sheer leg cranes are now available. ARS-50 Class salvage ships are capable of 350-ton tidal lifts. Refer to *ARS-50 OPS MAN*.

3-7.4 Mechanical Lifts. Salvage ships, lift craft and cranes use purchase lift systems to raise whole or parts of sunken ships. Some sheer leg cranes can lift over 3,600 tons. Combining crane and sheer leg purchases with deck purchases will increase the lift capacity. Submersible lift barges placed under partially sunken vessels are used for lifting. Navy salvage ships can bow lift up to 200 tons, lift craft 600 tons over the stern and commercial cranes over 7,500 tons.

3-7.5 Navy Salvage Ship Heavy Lift. The Navy's salvage ship heavy lift capacity is limited. The ARS-50 Class can make 300-ton dynamic lifts with installed equipment. Lifting is done with the main bow and stern rollers in conjunction with purchases and hydraulic pullers.

Hydraulic pullers are the preferred pulling power source for Navy lifting systems. Direct lifts of 75 tons or less with a hydraulic puller or towing machine are also possible. Refer to operating manuals for rigging details.

Navy standard beach gear purchases are too small for heavy lifts but are good for overhauling large heavy lift purchases that can weigh in excess of one ton per block.

THIS PAGE INTENTIONALLY LEFT BLANK

4-1 INTRODUCTION

A stranded ship is one grounded unintentionally. Lost buoyancy holds the ship against the bottom. The amount of lost buoyancy exactly equals the amount of weight supported by the ground and is called *ground reaction*. Refloating the ship from her strand requires reducing and overcoming ground reaction.

This Chapter discusses ground reaction calculation and reduction, freeing forces, pulling systems and refloating operations.

4-2 GROUND REACTION (R)

Ref: *SALMAN, VOL 1; SAL ENG*

Measure R , also called tons *aground*, in long tons. Assume ground reaction distribution is even along the ship's grounded length.

The center of R is the point about which the ship will pivot. Use this center, located equidistant from the ends of the grounded area, to determine effects of weight change.

Monitor ground reaction value continuously, because it changes with tide cycles and weight additions or removals.

Determine R based on bodily rise, trim, or a combination of the two. Use the method that fits the situation:

- Trim greater than one percent of the ship's length - use change in trim method
- Bodily rise with little change in trim - use tons per inch immersion method
- Trim and Rise - use change of displacement or change of draft forward method.

Do not use change of draft forward in situations with an un-

known center of ground reaction, or a center that is estimated with poor accuracy. The results may be inaccurate.

Always calculate ground reaction by two methods and compare the results. If the results are not close, **RECALCULATE.**

4-2.1 Change of Trim Method

Used with known center of ground reaction and in cases when trim exceeds 1 percent of the ship's length.

$$R = \frac{(MT1)(t)}{d_r}$$

where:

$MT1$ = moment to trim one inch

t = total trim in inches

d_r = distance from center of flotation to center of R (feet)

4-2.2 Tons Per Inch Immersion (TPI) Method

Good for the first ground reaction estimate, based on bodily rise only. Determine R by:

$$R = (T_{mbs} - T_{mas}) \times TPI = \delta T_m \times TPI$$

where:

T_{mbs} = mean draft before stranding

T_{mas} = mean draft after stranding

TPI = tons per inch immersion

4-2.3 Change in Displacement Method

Forward and aft drafts are used with functions of form diagram or curves of form.

$$R = \Delta_b - \Delta_g$$

where:

R = ground reaction

W_b = displacement immediately before stranding

W_g = displacement after stranding

Note: For trimmed ships, make a correction to displacement for trim. See Para 1-3.1.8, *SALMAN, VOL 1*.

4-2.4 Change of Draft Forward Method

Used with known ground reaction center.

$$R = \frac{(TPI)(MT1)(L)(T_{fa} - T_{fs})}{[(MT1)(L) + (TPI)(d_f)(d_r)]}$$

where:

T_{fa} = draft forward before stranding

T_{fs} = draft forward after stranding

d_f = distance from the center of flotation to the forward perpendicular

d_r = distance from the center of flotation to the ground reaction center

4-2.5 Ground Reaction and Weight Movement

Buoyancy and ground reaction support a stranded ship. Buoyancy plus ground reaction exactly equals the ship's weight, or:

$$W = B + R$$

The following statements apply to weight changes:

- Weight removal is the preferred method for reducing ground reaction.
- Weights added or removed at the center of ground reaction cause a **change** in ground reaction **equal** to the weight change. There is **no change** in buoyancy.
- Weights added or removed at the neutral loading point cause a **change** in buoyancy **equal** to the weight change. There is **no change** in ground reaction.
- **Adding weight forward** or **removing weight aft** of the neutral loading point will **increase** ground reaction.
- **Removing weight forward** or **adding weight aft** of the neutral loading point will **decrease** ground reaction.
- Check changes in forward and after drafts following weight changes and when major weight changes are in progress.
- After tide cycles, check predicted readings against actual draft readings. If the readings differ, the ship is not pivoting about the center of ground reaction. Actual change in ground reaction is different from predicted.
- **Shifting** weight does not affect displacement nor does it cause parallel rising or sinking. The height, longitudinal and transverse position of the center of gravity may change.

4-2.6 Neutral Loading Point (NP)

Grounded ships have a neutral loading point where adding or removing weight does not affect ground reaction. Locate *NP* by:

$$d_n = \frac{(MT1 \times L)}{(TPI \times d_p)}$$

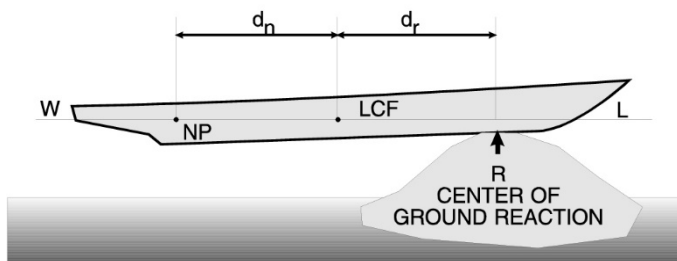

Figure 4-1. Distances Needed to Locate the Neutral Loading Point.

where:

d_n = distance from the Longitudinal Center of Flotation to the NP

$MT1$ = moment to change trim one inch

L = length between perpendiculars

TPI = tons per inch immersion

d_r = distance from the center of the ground reaction to the LCF

4-2.7 Tide and Ground Reaction

Rising tides increase buoyancy and reduce ground reaction by the same amount. Falling tides reduce buoyancy and increase ground reaction by the same amount. Calculate ground reaction changes as follows:

- For a ship that cannot trim - multiply the change in the height of tide by TPI
- For a ship that will trim - determine by:

$$\delta R = \frac{(t)(TPI)(MT1)(L)}{(TPI)(d^2) + (MT1)(L)}$$

where:

- δR = ground reaction equal to tide change
- t = tide change in inches
- L = ship length
- d = distance between the ground reaction pressure center and the longitudinal flotation center.

4-2.7.1 Measuring Tides

Knowing the exact tide at all times is essential to salvage planning. Measure tide changes as precisely as possible. Construct a tide gage well clear of the salvage operation that will be visible at night.

4-3 FREEING FORCE (F)

Refloating the stranded ship requires generating sufficient freeing force to overcome ground reaction. Measure F in short tons.

4-3.1 Determining Freeing Force. Estimate this force by multiplying ground reaction by a coefficient of friction μ :

$$F = 1.12\mu R$$

where:

- F = pulling force required to free the stranded ship in short tons. F is a general guide, because frictional effects vary greatly. Plan to use excess pulling assets. Assume the highest value for the freeing force.
- μ = coefficient of static friction. See Para 4-3.1.1.
- R = ground reaction in long tons
- 1.12 = Converts ground reaction from long tons to short tons by multiplying the computed force by 1.12

4-3.1.1 Coefficients of Friction (μ). Coefficients of friction change from static to dynamic when the stranded ship starts re-

tracting. Dynamic coefficients of friction are much lower. When the ship stops moving, μ reverts to the higher static coefficient of friction.

Table 4-1. Coefficients of Static Friction.

Type of Bottom	Coefficients of Friction
Silty soil or mud	0.2 to 0.3
Sand	0.3 to 0.4
Coral	0.5 to 0.8
Rock	0.8 to 1.5

The following increase friction coefficients:

- Impalement or sharp points protruding into the ship. Remove before pulling.
- Damage to the ship's hull. Add at least .05 to coefficient.
- No uniform or sloping bottom
- Unit intensity of pressure (loading tons per square foot)
- Ship's underwater body shape in contact with bottom
- Bottom suction.

4-4 REFLOATING OPERATIONS

Refloating operations have three phases: stabilization, refloating and postrefloating.

4-4.1 Stabilization Phase. Contact the ship as soon as possible to determine what has been done. Take immediate action with stranded ship personnel to avoid total loss. As a minimum, advise the Commanding Officer to evaluate:

- Safety of personnel

- Weather and sea conditions including forecast changes
- Current and tide
- Nature of the seafloor, shoreline and depth of water around the ship
- Damage and risk of further damage
- Maintaining continuous communications
- Pollution and the risk of potential pollution
- Ground reaction
- Draft and trim, if the ship refloats.

Advise the Commanding Officer to:

- Avoid jettisoning weight to lighten ship as this can result in weather driving the lightened ship further ashore. Removing low weights may impair stability.
- Stabilize the ship and determine its overall condition.
- If the ship is lively, avoid broaching through judicious use of engines, tugs, pusher boats and lines to rocks, coral heads or anchors.
- Ballast or flood compartments to increase ground reaction to hold the ship from further grounding.
- Avoid backing off attempts with a torn bottom. This can cause additional bottom damage or sinking.
- Request salvage assistance immediately.
- Try backing off at high tide only if it is certain that the ship will not capsize, sink or broach.

4-4.1.1 Immediate Pull. General guidelines to determine whether or not to attempt an immediate pull include:

- Severely stranded ships are rarely refloated without a

- sizeable pulling effort unless there are extreme tidal ranges.
- Heavily laden ships grounded at high speed must be lightened significantly before beach gear becomes effective.
- A ship lightly aground at low tide with little damage may refloat with higher tide and a moderate pulling force.
- Evaluate whether damage will allow the ship to structurally resist the new loading conditions in a seaway.
- Sufficient bollard pull must be available. Assess this as follows:
 - Determine the maximum bollard pull of each tug.
 - Estimate the reduction in pull caused by the conditions on site. If the casualty is impaled or badly holed, avoid using tugs at this point.
 - Determine the amount of excess of expected bollard pull needed above the freeing force. 25 percent to 30 percent is a desirable excess.

4-4.1.2 Estimating Bollard Pull (BP). Estimate bollard pull using brake horsepower (BHP) or shaft horsepower (SHP). Brake horsepower is power developed by the engines. Shaft horsepower is power delivered to the propeller. Different formulas determine BP from BHP depending on the type of propulsion system.

Table 4-2. Calculating Bollard Pull.

Propulsion System	Formula
Open fixed-pitch propeller	$BP = 0.011 \times BHP$
Open controllable-pitch propeller	$BP = 0.012 \times BHP$
Shrouded fixed-pitch propeller	$BP = 0.013 \times BHP$
Shrouded controllable-pitch propeller	$BP = 0.016 \times BHP$

Table 4-2. Calculating Bollard Pull. (Cont'd)

where:

- BP = Bollard pull in short tons
- BHP = Design main engine brake horsepower
- BHP = If only shaft horsepower (SHP) information is available, multiply SHP by 1.05

Indicated or Installed Horsepower (IHP) is often used to describe tug horsepower. If possible, do not use IHP in bollard pull calculation, as IHP is not reliable. When only IHP information is available, estimate brake horsepower by multiplying IHP by 0.75.

Bollard pull estimated in Table 4-2 is the maximum pull produced by a tug developing its full engine power in calm water. The effective bollard pull may be only one-half of the maximum, if:

- Seas are rough
- Rudder is constantly over to maintain course
- Towline is not leading directly astern.

4-4.2 Refloating Phase. Involves close coordination of all salvage efforts. Listed throughout this handbook are specific plans such as rigging beach gear, dewatering, patching, etc., necessary for refloating the stranding. Recognize the dangers of overlooking any of the following areas:

- Direction of refloating. Usually reciprocal to grounding course. Make hydrographic surveys in this direction.
- Connections on the stranding. Check for strength to hold the highest pulling forces. Double backup when using bits for attachment. Add chain where sharp edges could cut wire. Inspect padeyes for cracks and try to determine the rated capacity.
- Tugs. Check for sufficient water depth to maneuver. Avoid mutual tug interference. All tows should be the same length when using multiple tugs. Avoid fouling beach gear legs. Ease tows to position tug propellers

- well seaward of ground leg water entry points. Pull in tandem to increase bollard pull. Rig Liverpool bridles where necessary and use tugs for fast wrenching.
- Rigging the ship for tow. Rig messengers, towing bridle, day shapes, tow lights and towlines before refloating. Paragraph 6-5 has an abbreviated towing bridle check-off list.
- Anchor drag. Recognize common causes such as:
 - Anchors improperly dug in
 - Improper fluke angle for the soil
 - Balling of soil on the flukes
 - Rolling of the anchor caused by ineffective or improperly deployed stabilizers
 - Chain fouled on the flukes
- Before retraction, decide where to take the ship. Possible disposition may include:
 - Steaming into port
 - Towing to a safe haven
 - Anchoring to make preparations for tow or to make temporary repairs of damage caused by grounding or refloating
 - Beaching the ship if it is in danger of sinking
 - Scuttling or sinking.

4-4.3 Post Refloating Phase. Starts when the ship begins to retract and ends when:

- The operational commander or owner receives the ship.
- All salvage equipment is recovered, overhauled and restowed.
- The salvage reports required by NAVSEAINST 4740.8 (series) and other current directives are completed.

4-4.3.1 Immediate Action Following Retraction. Paragraph 4-6.4.1 discusses slipping beach gear and rigging for tow or anchoring. Items to consider prior to transit or towing are:

- Controlling the ship's way
- Securing the ship and portable equipment for transit
- Repairing holes in the hull. Add external patches to holes that were previously inaccessible.
- Checking for new damage or previously unreported holes
- Stopping pollution
- Conducting thorough internal, external and underwater surveys
- Recovering beach gear.

4-5 REDUCING GROUND REACTION

Refs: *SALMAN, VOL 1; SAL ENG*

Ground reaction reduction using the following methods can bring the freeing force within the pulling system capacity:

- Weight management
- Inducing or restoring buoyancy
- Ground removal
- Lifting
- Temporary reductions.

4-5.1 Weight Management

Weight management is widely used to reduce ground reaction in most strandings. Included are weight removal or redistribution, temporary weight replacement and weight effects on stability and strength. Always consider environmental pollution when moving or jettisoning cargo.

4-5.1.1 Weight Changes. Coordinate all weight movement to maintain stability. Use a weight control log to record:

- Weight taken aboard, removed, or relocated
- Weight location and movements above the keel, off-centerline and fore and aft
- Calculate the new *G* position and list, trim and stability effects, using the methods in Sec2-6.1.

4-5.1.2 Temporary Weight Replacement. Keeps the ship in position when removing permanent weight. Ensure that ground tackle is in place before moving weight and consider:

- Replacement weight effects on stability
- Methods for containing replacement weight such as fabricated tanks, portable bladders and upper deck compartments
- Methods for rapid-replacement weight removal, such as quick-opening valves.

4-5.2 Inducing or Restoring Buoyancy. Flood water removal from spaces with:

- Pumps. Good for removal below the waterline.
- Air compressors. Good for voiding double bottoms or other spaces capable of holding air bubbles.
- Buoyant material. Good when compartment is difficult to make watertight.

4-5.3 Ground Removal. Increases draft by allowing ship to sink deeper. Methods are:

- Scouring. Effective in soft soils. Done with prop wash, currents, jetting pumps. **Be cautious not to create excess hogging stresses.**

- Dredging. Good for removing large soil quantities.
- Rock Removal. Difficult even with jackhammers or explosives.

4-5.4 Lifting. Physically lift the ship with the following:

- Jacks. Hard seafloor required. Time-consuming to reset jacks with divers.
- Pontoons. Inflatable salvage pontoons, spring buoys, lift bags and buoys rigged alongside or under the hull.
- External lift with cranes and sheer legs. Effective, but difficult to use when stranding is exposed to heavy seas and swells.
- Barges and lift craft. Use slings under the ship for tidal and ballast lifts.

4-5.5 Temporary Reductions. Rising tides or artificial swells reduce R. Jetting pumps or air lancing reduce friction during the pulling attempt.

4-6 BEACH GEAR

Refs: *SALMAN, VOL 1; SAL ENG; ESSM CAT*

Beach gear, designed to 60 tons per leg, generates freeing force to overcome R and friction. Beach gear discussed in this section is that carried on the ARS-50 Class salvage ship and in the ESSM system. Follow specific ship operating manuals when rigging beach gear.

The deck arrangement and ground leg make up beach gear. Rigging techniques and system components are the same on both a stranded ship and a pulling platform.

4-6.1 Deck Arrangement

Linear (hydraulically powered) pullers, cable holders and tension measuring instruments make up the deck arrangement. When pullers are not available or suitable, substitute fourfold purchases.

4-6.1.1 Linear Pullers. The linear pulling system consists of:

- Puller. Two grips alternately hold and pull the 1-5/8-inch ground wire.
- Power Supply. Installed or portable. One portable power supply required per puller.
- Control Block. Portable, for operating where visibility is best. Connected to puller and power supply with hose.
- Tensiometer. Installed between puller bridle and deck attachment padeye.

The preferred beach gear operating method is to rig hydraulic pullers on and pull from the stranded ship. Rig the system as follows:

- Locate 1-5/8-inch holding carpenter stopper inboard of 1-5/8-inch ground leg wire entry point.
- Locate hauling stopper outboard of the ground leg wire opposite the holding stopper. Haul wire rope fittings around the puller with a hauling stopper attached to a short 1-5/8-inch pendant.
- Secure puller unit to deck padeye with a fairlead to the ground leg wire entry point.
- Connect tensiometer between puller and deck padeye attachment point.
- Connect hydraulic power pack and control console to pullers. Locate control console at the point of best visibility.

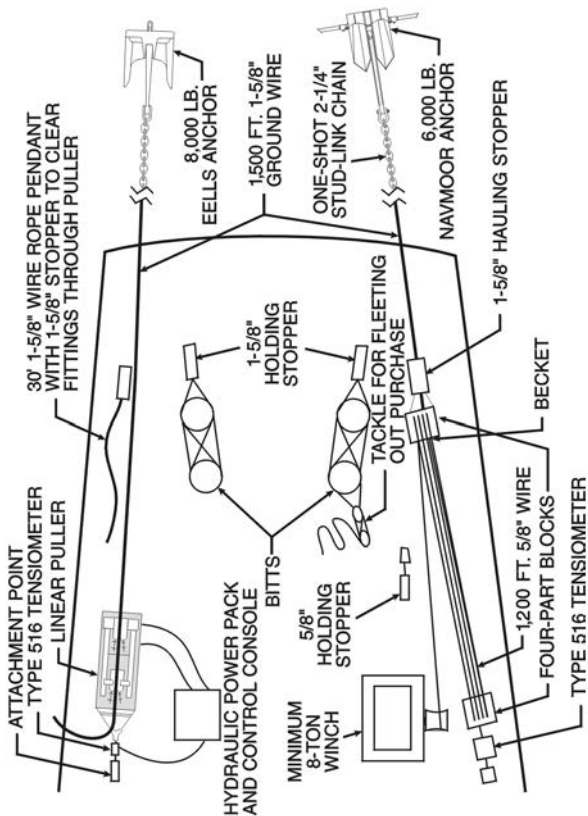

Figure 4-3. Standard Navy Hydraulic and Purchase Deck Arrangement.

4-6.1.2 Deck Purchases. The Navy standard beach gear purchase system is standardized, easily portable and used to augment the hydraulic powered systems. The fourfold, purchase-hauled system includes:

- Two 5/8-inch, four-sheave blocks with the becket on the traveling block.
- Wire rope. 1,200 feet of 5/8-inch, improved plow steel, fiber core, 6 x 37, uncoated wire rope for reeving the quadruple blocks. Attach the wire rope to the becket with four wire rope clips.
- Carpenter stoppers. Sliding wedge block stoppers designed to hold wire rope without damage up to the wire rope's breaking strength. Four Carpenter stoppers per beach gear leg. Two 5/8-inch stoppers to haul and hold the purchase wire. Two 1-5/8-inch stoppers to haul and hold the ground leg wire.
- Fairlead blocks. Fairlead blocks change wire rope direction. Use 5/8-inch fairleads for a direct lead to the winch or capstan. Align the ground leg wire to the traveling block with 1-5/8-inch fairleads.
- Tensiometer. Between the standing stopper and padeye.
- Connecting Hardware. Connects purchases, fairlead blocks and stoppers to deck fittings. See *ARS-50 OPS MAN* and *ESSM CAT* for exact size of connecting hardware.

4-6.1.3 Rigging Purchase Deck Arrangement. Purchase systems augment pullers or become the primary pulling system when salvors are unable to transfer pullers to the stranded ship. An 8-ton line pull power source is needed. Rig purchase gear as follows:

- Secure 1-5/8-inch holding stopper inboard of where 1-5/8-inch ground leg wire leads aboard.
- Secure 5/8-inch standing block and tensiometer to padeye for maximum travel.
- Shackle 1-5/8-inch hauling stopper to 5/8-inch fourfold traveling block.
- Reeve 5/8-inch blocks center-to-center with 5/8-inch wire rope to reduce traveling block turning after loading.

- Secure 5/8-inch stoppers next to standing block and winch to hold the purchase from fleeting out after heaving stops.
- Insert steel bars or timbers through 5/8-inch bridles to reduce purchase wire twist.
- Secure fairlead blocks where needed

4-6.2 Ground Leg

Ground legs are rigged with an anchor, chain, wire rope, retrieving and crown wires and buoys. Ground leg components and specifications are:

- Anchor. NAVMOOR, 6,000-pound (primary); STATO, 6,000-pound; EELLS, 8,000-pound. Paras 3-5.2, Figures 3-4 through 3-6 and Tables 3-12 through 3-14 describe anchor performance.
- Chain. 90-foot, 2-1/4-inch, welded stud link chain keeps the anchor shank parallel to the seafloor when it is flat or sloping down away from the stranded ship. **Smaller chain or wire rope replacing the standard 2-1/4-inch chain should weigh a minimum of 4,250 pounds.**
- Wire rope. 1-5/8-inch diameter, improved plow steel, drawn, galvanized, preformed, right-hand lay, fiber core, Type 1, Class 3, 6'37, Warrington-Seale wire rope, military standard RR-W-410. Breaking strength 192,600 pounds. Manufactured in 50- and 100-fathom lengths. **Wire rope is the ground leg's weakest part.**
- Retrieving pendant or wire. 100- or 200-foot lengths, 1-1/4-inch diameter, improved plow steel, drawn, galvanized, preformed, right-hand lay, fiber core, Type 1, Class 3, 6'37 Warrington-Seale wire rope. Breaking strength 119,000 pounds. Attached to the 1-5/8-inch ground leg wire bitter end for retrieving and passing the ground leg wire to the stranded ship or pulling platform.
- Crown pendant or wire. Same type and lengths as the retrieving pendant. Shackled to the anchor crown to aid in recovering or resetting the anchor. Breaking out tandem anchors may require heavier wire rope.

- Retrieving and Crown Buoys. The buoys support their respective pendants and act as reference marks. **One buoy will support three 100-foot lengths of 1-1/4-inch wire rope pendant. Recalculate the correct number of buoys to use with larger wire rope.** Refer to Table 4-4 for wire weights and *SALMAN, VOL 1* for calculating net buoyancy.
- Connecting Hardware. ARS-50 OPS MAN and ESSM CAT list ground leg connecting hardware 4-6.2.1 Ground Leg Rigging and Laying

The way the ground leg is passed to the stranded ship dictates how it should be rigged for laying. Laying techniques are:

- **Preferred method. Attach the 1-5/8-inch bitter end to the stranded ship and stream the ground leg seaward.** Drop the chain and anchor as the strain reaches them. The crown buoy is the last to drop.
- Secondary method. Drop the anchor and chain seaward and stream the ground wire as the ship steams toward the stranding reciprocal to the retraction direction. The anchor is cut free at a preset distance or bearing. The chain and wire stops part as the ship continues to close the stranding. The ground leg wire bitter end should drop close to the stranding's seaward end. The retrieving buoy is the last to drop. Haul the ground leg wire aboard the stranded ship with the retrieving wire.
- Alternate secondary method. Lay the ground leg as described in the secondary method, but several hundred feet farther seaward. Haul the ground leg wire aboard the salvage ship with the retrieving wire. Secure a tow wire to the stranding and heave from the salvage ship.

Figure 4-4 Reeving Blocks Illustrates two methods of reeving the blocks. The center-to-center method is preferred because it reduces the tendency of 5/8-inch rope to turn the traveling block as load is applied. The round-robin method may also be used.

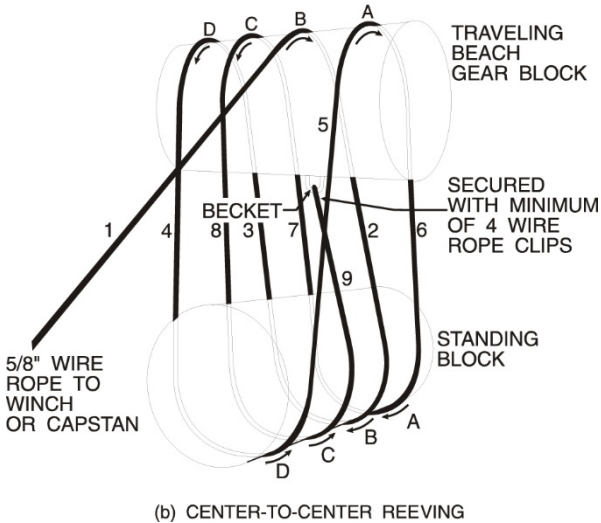
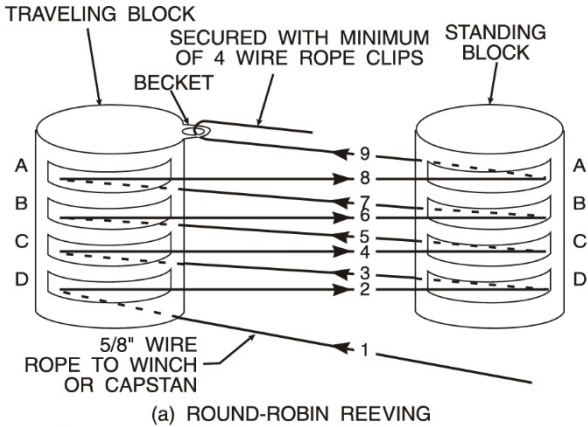

Figure 4-4 Reeving Blocks

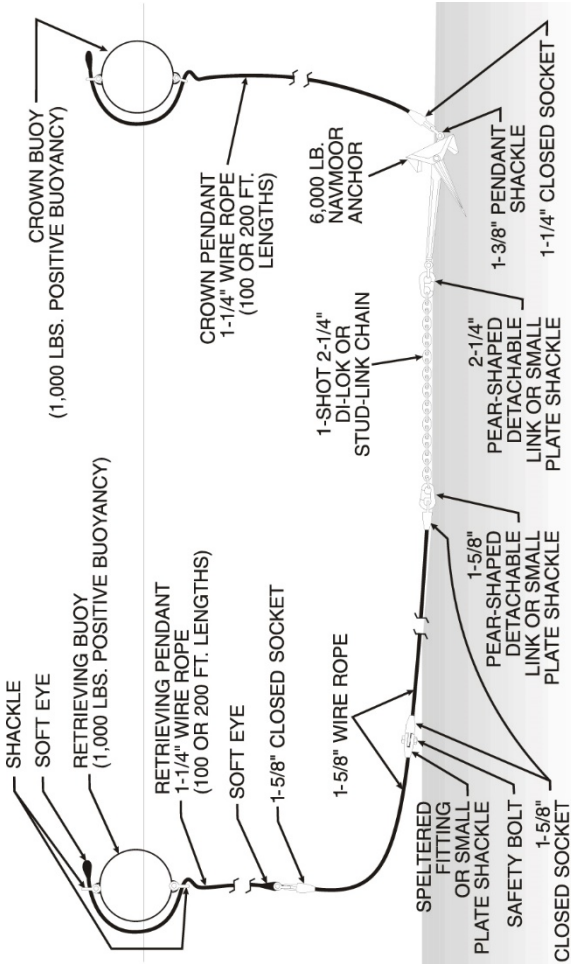

Figure 4-5. Navy Standard Beach Gear Ground Leg.

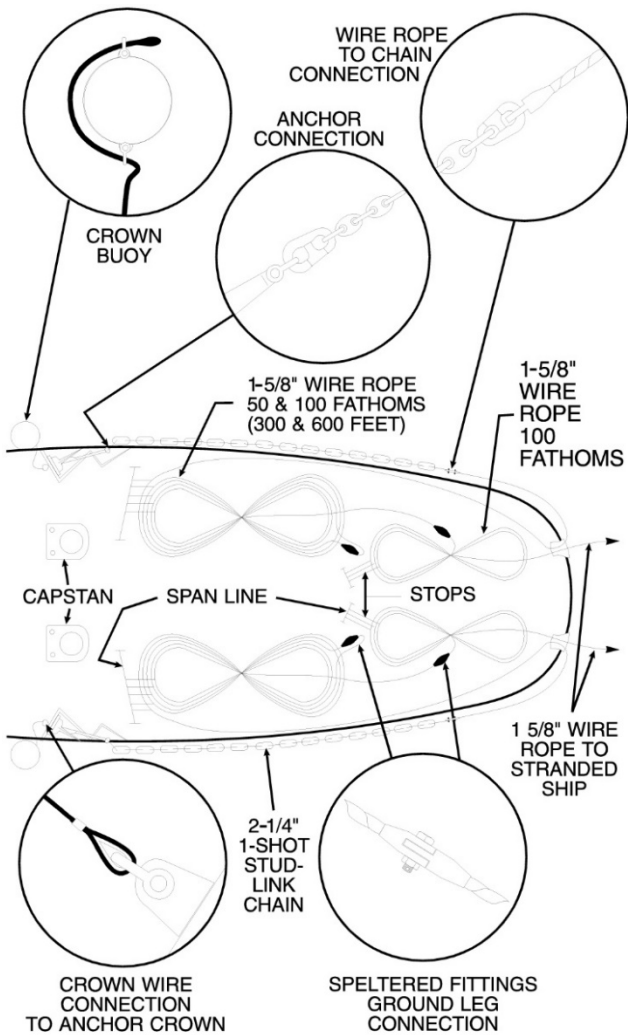
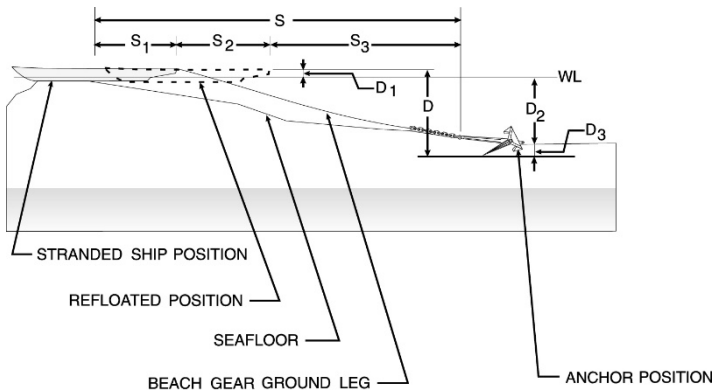

Figure 4-6. Rigging to Lay Ground Legs Seaward from Stranding.



$$\text{ANCHOR DEPTH (D)} = D_1 + D_2 + D_3$$

WHERE:

D_1 = HEIGHT OF SHIP'S DECK ABOVE WATER

D_2 = WATER DEPTH AT ANCHOR LOCATION

D_3 = ANCHOR EMBEDDED DEPTH

$$\text{MINIMUM GROUND LEG SCOPE (S)} = S_1 + S_2 + S_3$$

WHERE:

S_1 = LENGTH OF WIRE ROPE NEEDED ON DECK

S_2 = DISTANCE TO MOVE SHIP FOR REFLOATING

S_3 = BASIC GROUND LEG SCOPE

Figure 4-8. Distances for Determining Ground Leg Scope.

Table 4-3. Basic Ground Leg Scope.

Anchor Holding Power - 50 Tons Basic Ground Leg Scope (S)			
Anchor Depth (D) Feet	1-5/8" Wire Rope and one shot of 2-1/4" Chain	1-5/8" Wire Rope and two shots of 2-1/4" Chain	1-5/8" Wire Rope and three shots of 2-1/4" Chain
60	1,120 feet	787 feet	—
84	1,420 feet	1,022 feet	823 feet
108	1,687 feet	1,240 feet	998 feet
132	1,929 feet	1,445 feet	1,166 feet
156	2,153 feet	1,639 feet	1,328 feet
180	—	1,822 feet	1,485 feet
204	—	1,998 feet	1,636 feet
228	—	2,166 feet	1,782 feet
252	—	—	1,924 feet
276	—	—	2,062 feet
300	—	—	2,197 feet

4-6.2.1 Determining Minimum Scope

Determine minimum ground leg scope as follows:

- a. Figure the anchor depth by summing:
 - (1) The height above the waterline of the deck upon which the heaving gear is rigged. Do not use the height of the deck above the water if a spring buoy is rigged in the ground leg.
 - (2) The depth of water at the anchor.
 - (3) The embedded depth, which equals:
 - (a) 0 feet for firm sand or clay, coral, or rock
 - (b) 5 feet for medium-density sand or clay
 - (c) 10 feet for soft mud.
- b. Enter Table 4-3 with the anchor depth and read the basic ground leg scope. The basic ground leg scope includes the drag required to set the anchor properly.
- c. To obtain the minimum ground leg scope, add the distance the ship must travel to refloat and the length of wire rope on deck to the basic ground leg scope. When laying beach gear to a salvage ship or barge, omit from the calculation the distance the ship must travel.
- d. The total length of components that make up the ground leg should equal or exceed the minimum ground leg scope. Shorter scopes will cause anchor drag.
- e. As chain and wire rope come in standard lengths, use the next longer scope, made up with the components on hand.

4-6.2.2 Rigging the Ground Leg Over the Side. Rig the ground over leg over the side if billboards or stern chutes are not available. Procedures are:

- a. Rig the anchor outboard of a strong support point. Stop the anchor off with several turns of 4- or 5-inch manila.
- b. Stop the chain off over the side using strands of unlaaid 3-1/2-inch manila. Rig 5/8-inch wire rope preventers to avoid letting the chain go prematurely.
- c. Rig the wire rope over the side the same as the chain, or figure-eight it on deck. Lead the wire rope bitter end back through an opening large enough to allow the wire to run free.
- d. Using small stuff, stop crown and retrieving buoys and pendants over the side.

4-6.2.3 Passing the Tow Wire

This procedure is part of the alternate method of laying beach gear.

- Pass a messenger and line to a capstan on the stranding and haul the tow wire from the stranding aboard the towing ship.
- Pass a messenger and line through a block on the stranding back to a capstan on the towing ship. Heave the tow wire from the salvage ship to the stranding.
- Attach flotation cells to reduce the tow wire weight on the messenger line and prevent fouling on the seafloor.

4-6.3 Effective Hauling Force. Navy standard beach gear is rated at 60 tons pulling power per set, but averages about 50 tons because of friction loss and anchor drag. Determine the effective hauling force or number of beach gear legs required by:

$$N = (F - BP) / 50$$

where:

- N = number of legs. If the results contain a fraction, round to the next higher whole number.
- F = freeing force to overcome ground reaction in tons
- BP = bollard pull in tons of salvage ship or tug

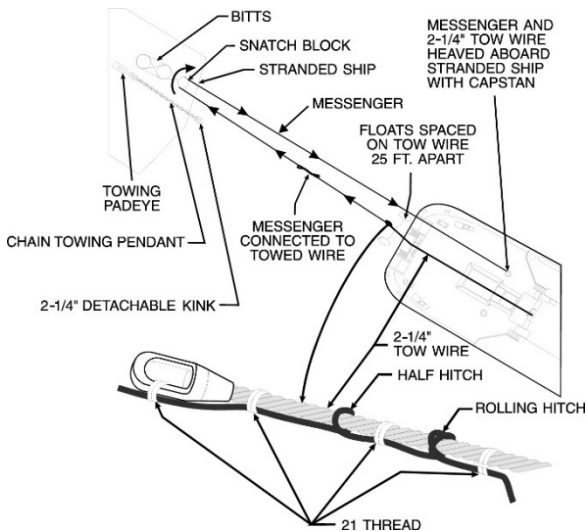

Figure 4-9.

50 = average beach gear pulling power in short tons. Pulling angles not parallel to the direction of retraction will reduce pulling power on that leg. Multiply the cosine of the angle, measured between the planned and actual direction of the wire, by 50. Substitute this figure for 50 tons.

4-6.4 Heaving Operation. Review the pulling plan and check communications before heaving. In designing the heaving plan:

- Avoid premature pulls.
- Build up pulling power slowly.
- Reach maximum pull two hours before high tide.
- Generate maximum pull throughout high water.
- Schedule pulling to coincide with heavy weather.
- Monitor tensiometers constantly.
- Set up a system for marking movement.

- Stop when losing tension from anchor drag.
- Include preparations to cast off the beach gear and anchor, or take the refloated ship in tow.

Build up beach gear pull slowly and well before high tide. Beach gear legs must be at maximum pull at high tide. After reaching sufficient freeing force through a combination of reduced ground reaction and maximum pull, the stranded ship will begin to move. Ground leg wires are hauled aboard with the movement.

When retraction begins, friction changes from static to dynamic. Maintain movement to avoid returning to static friction.

Staggering the strain between beach gear legs allows purchase overhaul and movement to proceed simultaneously.

4-6.4.1 Retraction and Refloating. Sudden slack in all beach gear legs is an unmistakable sign that the ship has floated free. Once afloat, the ship can move seaward with high velocity. Slip the beach gear after the ship is afloat as follows:

- Lead previously attached ground wire retrieving pendants and buoys back through the wire rope entry point.
- Trip the ground leg wire rope from the hauling Carpenter stoppers.
- Ease the ground wire out with a line until it is overboard.
- Cut the retrieving wire and buoy stops with the strain.

Slip puller-hauled systems as follows:

- Take up the ground leg strain on a standing stopper.
- Free the ground wire from the puller.
- Lead the ground leg wire bitter end back through its entry point.
- Connect the prerigged retrieving pendant.

- Trip the wire from the standing stopper.
- Ease the wire overboard.

THIS PAGE INTENTIONALLY LEFT BLANK

5-1 INTRODUCTION

Many salvage operations involve sunken or partially sunken ships. The same basic procedures are used to correct either condition—restore the watertight envelope and remove the water. These two actions restore buoyancy to aid in refloating.

This chapter addresses patching, using cofferdams and removing floodwater.

5-2 PATCHING

Ref: *SALMAN, VOL 1; SAL ENG; Underwater Cut and Weld*

Welding steel plate over the hole is the preferred patching method.

Patching restores a ship's watertight envelope. A good patch:

- Resists hydrostatic pressure
- Seats itself with ambient pressure
- Remains in position until the hole is permanently repaired.

Assume that damage control patches are insufficient and inspect them carefully for strength and survivability. **It is advisable to replace damage control patches with salvage patches.**

Holes below the waterline in spaces that have been dewatered with compressed air may require both internal and external patches to accommodate pressure from both directions.

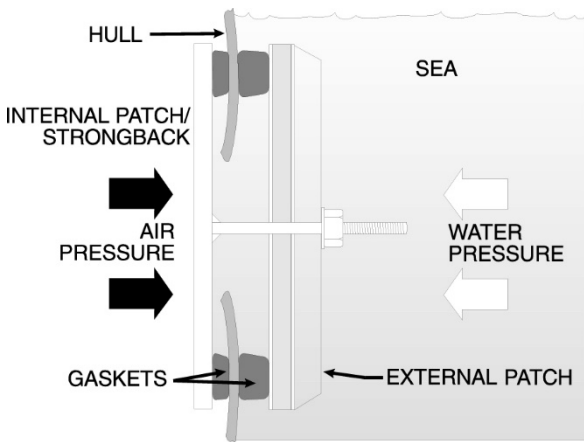

Figure 5-1. Double Patch.

5-2.1 Patch Types and Materials. Classify patches by the size of hole they cover or plug. Choose patching materials by accessibility, size and hole location. Hole sizes, patch types and materials used are:

- Small. Cracks, loose seams, ruptured piping and holes up to 12 inches in diameter or width. Patch with small wooden plugs, oakum, sawdust, cement, epoxy and plastic paste, glass-reinforced plastics (fiberglass), wedges and damage control plugs from the pressure side of the leak. As a rule, one person can carry a small patch.
- Medium. Holes and cracks larger than 12 inches up to 3 feet by 8 feet. Patch with groups of wooden plugs and wedges, mattresses, blankets, wood and metal in combination. Medium patches usually require more than one person to carry and install. Divers clean the hull and install attachment points.
- Large. Holes with dimensions larger than door size. Construct large patches with steel plate, wooden planking and heavy timbers. Patch strength and hull curvature are significant design considerations. Cover large holes with steel or wooden built-up, American or box patches.

5-2.2 Patch, Deck, or Bulkhead Pressure. Pressure differentials can cause failure in a patch, bulkhead, or deck. Install shoring before removing water to prevent bulkhead failure when dewatering:

- Patched, submerged compartments with the ship on the bottom
- Compartments adjacent to flooded compartments
- A ship with submerged decks.

Pressure on a submerged patch, deck, or bulkhead is directly proportional to the depth over it. Measure water depth in flooded compartments open to the sea from the ocean surface to the compartment deck.

5-2.2.1 Determining Pressure

Pressure on the deck or bulkhead is:

$$p_h = 0.445d$$

where:

p_h = hydrostatic pressure in pounds per square inch

d = water depth in feet (salt water)

Patches must withstand the maximum pressure they encounter.

The hydrostatic pressure at any point is the same in any direction.

The average pressure force on a bulkhead in a partially flooded space is determined by the formula:

$$p_h = 0.445(d/2)$$

If a ship is rolling and pitching, pressures can be significantly greater, because the depth of the point changes.

5-2.3 Patch Construction

All patches must be watertight and strong enough to withstand the pressures at hole depth.

Patch thickness is a function of depth and stiffener spacing.

Determine patch plank thickness by the formula:

$$T = \left[\frac{48 \times D \times l^2}{S} \right]^{\frac{1}{2}}$$

where:

T = patch thickness in inches. Patch material should be the next greater size lumber or plate available

D = water depth in feet

l = distance between stiffeners in feet

S = allowable stress in patch in psi. For short-term patch service, allowable stresses are:

Wood	1,500 psi
Aluminum (shipbuilding)	8,000 psi
Mild steel	24,000 psi

For long-term service, including ocean tows, use 70 percent of the values above. Reinforce long-term service patches with concrete after dewatering.

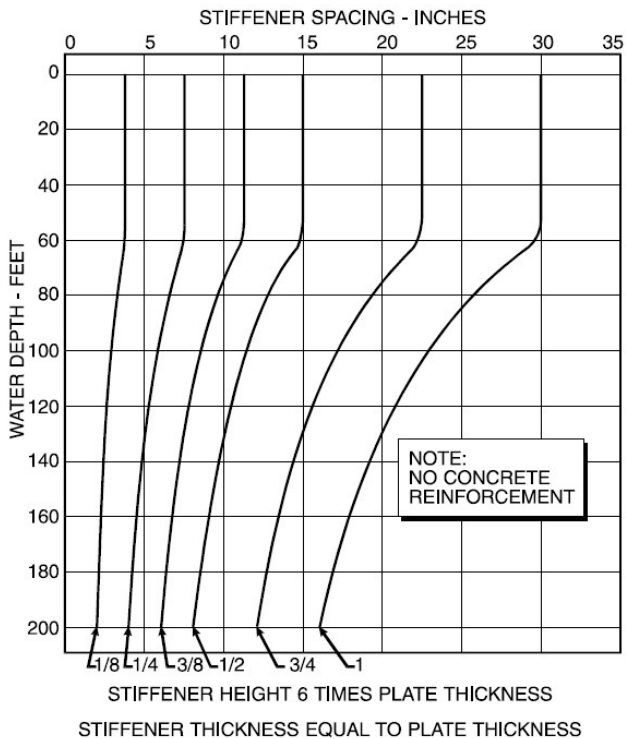

Figure 5-2A. Steel Patch Stiffener Spacing.

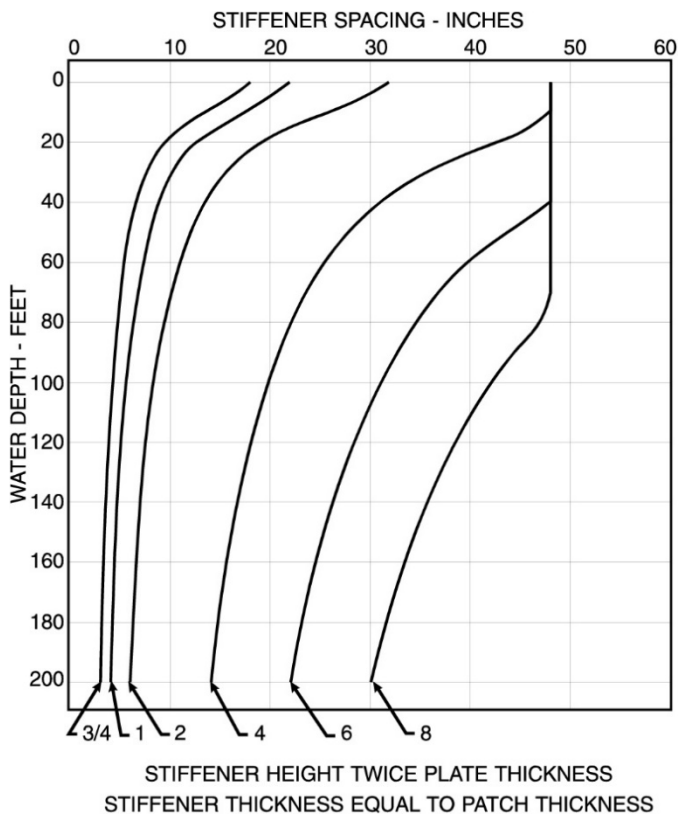

Figure 5-2B. Word Patch Stiffener Spacing.

Small patches can be made with plywood.

Wooden and steel patches may be doubled for additional strength. Doubled steel patches should be plug-welded and wooden planks nailed, screwed or bolted together.

Use foam rubber or other soft materials to create a watertight seal around the patch to overcome irregularities around the hole surface.

Build patches topside. Divers measure and install patches.

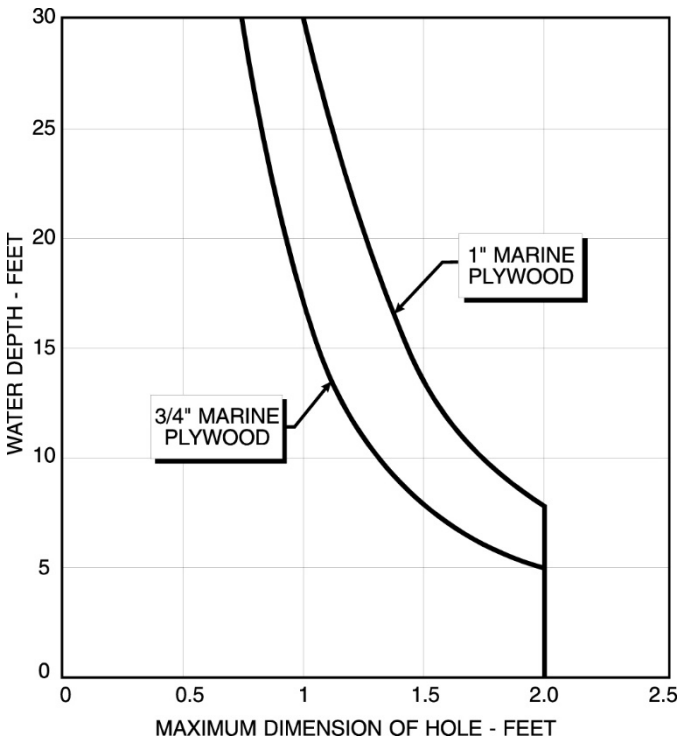

Figure 5-3. Plywood Patch Thickness

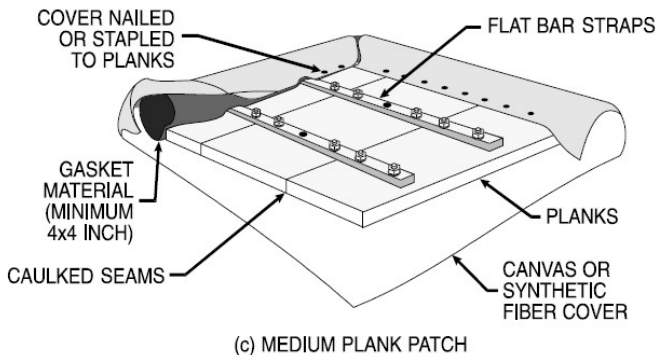
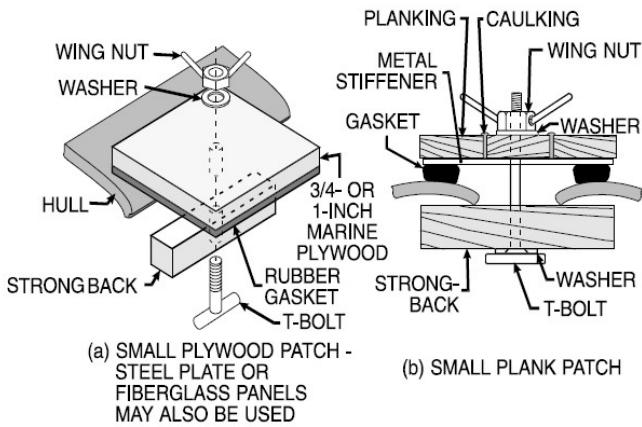

Figure 5-4. Wooden Patch Construction.

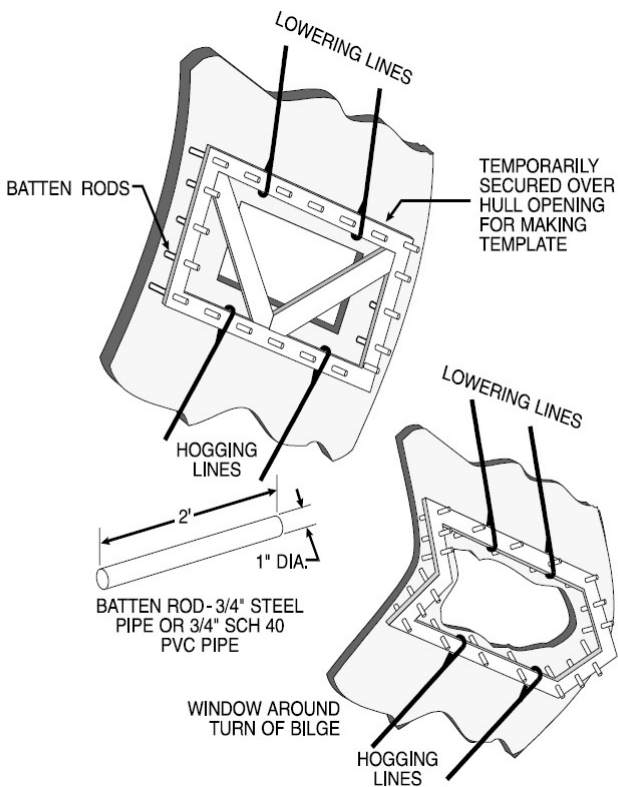

Figure 5-5. Hole Measuring Techniques and Device.

5-2.4 Patch Preparations

Preparations include:

- Sizing holes
- Clearing loose or protruding jagged metal and debris from the hole edges
- Clearing a path from surface to hole for ease of moving large patches into place over the hole.

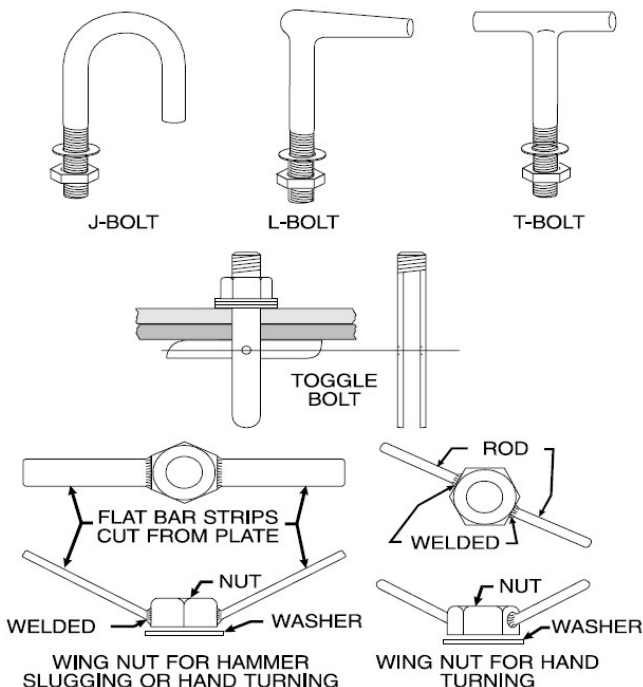

Figure 5-6. Patch Fasteners.

5-2.5 Measuring Techniques

Techniques include:

- Using a template to gage the size of holes at the turn of the bilge
- Constructing plywood mockups of the patch
- Setting up references for a detailed hole survey
- Hanging plumb lines over the side at each frame
- Marking by divers to show:
 - Damage beginning and end and number of frames between
 - Damage depth or height at each frame
 - Structural member locations
 - Approximate contour of the area requiring a patch
- Drawing the damage measurements to show:
 - General damage extent
 - General patch size required
 - Patch-stiffening and attachment points
 - Patch dimensions. Include the entire crack length.

5-2.6 Patch Placement Techniques:

- Position patches where pressure seats them tightly. Locate patches externally when pumping, internally when blowing.
- Patch holes internally when external access is blocked.
- Shore internal patches to prevent unseating by hydrostatic pressure.
- Double patch when pumping and blowing in the same space.

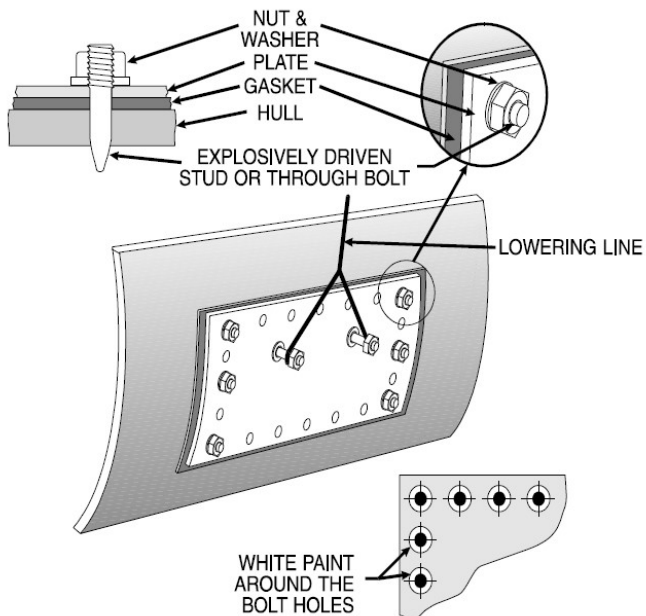

(a) BOLTED STEEL PATCH

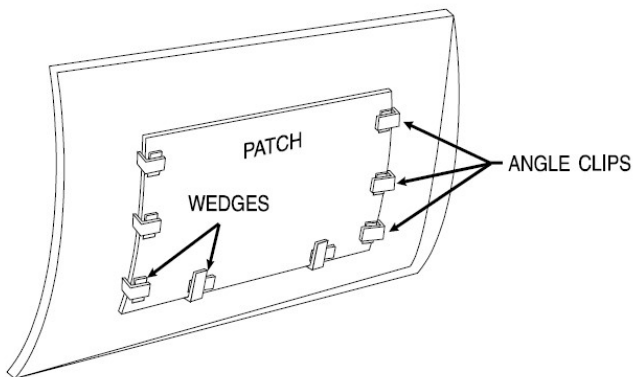

(b) WELDED STEEL PATCH (HELD IN PLACE WITH ANGLE CLIPS AND WEDGES FOR WELDING)

Figure 5-7. Bolted and Welded Steel Plate Patch.

5-2.7 Patch Fastening. Secure wooden patches with bolts or bolts and a strongback laid across the hole's inside. Butterfly nuts, made by welding round stock to the nut, aid tightening by divers. Attach wooden patches to wooden hulls with nails.

After dewatering a patched space, retighten all patches. Pressure differential compresses gasket material and loosens the patch.

Secure large patches in position by welding or shooting studs into the hull. Lower heavy patches from the surface with lines. Hold the patch against the hull with hogging lines.

Spot-welds can be used to close fine cracks and stop leaking through rivets and split seams.

5-2.8 Steel Patches

Steel plate is the preferred patching material. Its high strength makes it especially reliable on any size hole. Virtually every ship carries steel plate. Large steel plates cut from the ship's superstructure are suitable for patching.

1/8- to 1/4-inch-steel plate is adequate for small to medium sized holes discussed in Para 5-2.1. Mild steel plate is good for:

- Simple flat-plate patches for minor leaks
- Box patches
- Built-up or plate-panel patches
- Large, prefabricated patches to cover major leaks.

Use mild steel angles or channels to stiffen and reinforce large patches.

5-2.8.1 Welding. Welded patches are more likely to hold against the stresses caused in a seaway than wooden and concrete patches. See *UW CUT WELD MAN* for underwater welding techniques.

Welding is the preferred method of securing large steel patches to shell plating and bulkheads.

If unable to clean and prepare the hull or bulkhead surface for welding, bolt the patch and weld the bolted patch after pumping.

5-2.8.2 Bolting. Bolting is the most common method for securing small and medium steel patches in place over shell and bulkhead damage. Bolts are placed into the hull by friction stud welders, explosive stud guns and by holes drilled through the hull.

Position the patch over the damaged area with lowering lines and hold in place with hogging lines. Drill guide-holes as appropriate in the steel plate. Shoot studs or drill holes through the plate holes into the hull. Secure the patch with nuts tightened on the threaded studs.

Steel plate can be bent to fit mild hull curves. Install studs from the lower edge upward.

Stud-fastened steel patches are strong, watertight and semipermanent when seated on a rubber gasket and sealed with epoxy. Space studs at 10 to 12 inches.

5-2.8.3 Friction Stud Welding. Friction stud welders are excellent for fastening large steel patches and can be operated by any diver.

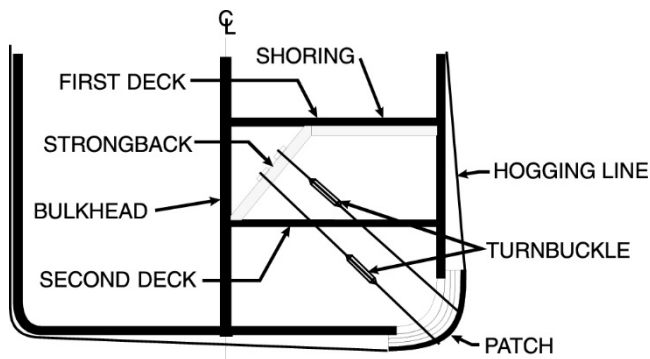

Figure 5-8. Patch Secured with Turnbuckle and Strongback.

5-2.8.4 Aluminum Patches. Aluminum plate may be used as a substitute for steel in non-welded patches.

5-2.9 Wooden Patches.

Wooden patches are common because wood is easy to work with and is readily available. Unfinished, easily worked softwood is preferable, because it is common in ships. Wood's ability to crush, deform and swell in water results in tight seals. Wooden patches temporarily halt flooding until more secure steel patches are installed. Heavy wooden patches can hold in high seas during transit to a repair facility. However, if possible, replace wooden patches with welded steel patches before getting underway.

5-2.9.1 Small Wooden Patches. Minimum tools, material and effort are needed to construct small planked wooden patches. Build small wooden patches by laying planks edge-to-edge on canvas or synthetic fabric. Attach light steel reinforcing angles to the planks.

5-2.9.2 Large Wooden Patches. Build large wooden box and plank-on-plank patches in place over the hole or damage with heavy planks or beams. These patches are relatively rare in modern salvage work. If building large patches is necessary, refer to *SALMAN, VOL 1*

Use a combination of strongbacks and turnbuckles to aid in holding large external patches in place. Attach the turnbuckles to an external strongback. Anchor the turnbuckle inside the ship after it passes through the patch. Tighten against the strongback to secure the patch.

5-2.10 Concrete Patches

Pour concrete internally to serve as a patch or to support external plate patches. Look closely at concrete patches' negative aspects before using them. Concrete patches require:

- Significant labor to remove
- Large, complex forms and shoring to support the weight
- Counterweights to offset list caused by the patch
- Reducing R , or adding more pulling forces in amounts equal to the added weight.

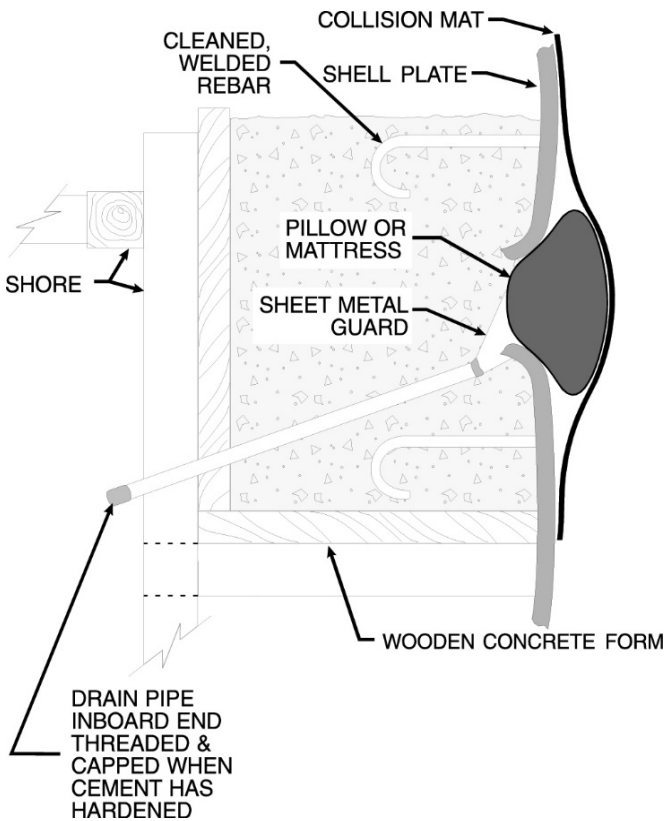

Figure 5-9. Small Concrete Patch.

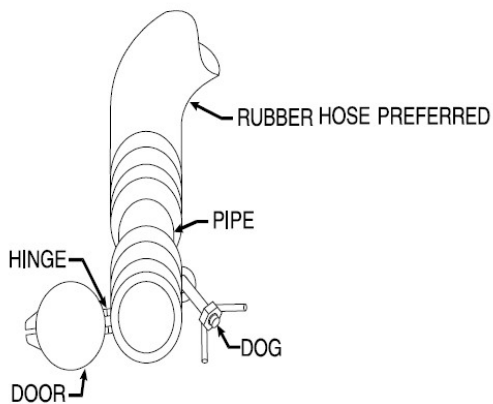
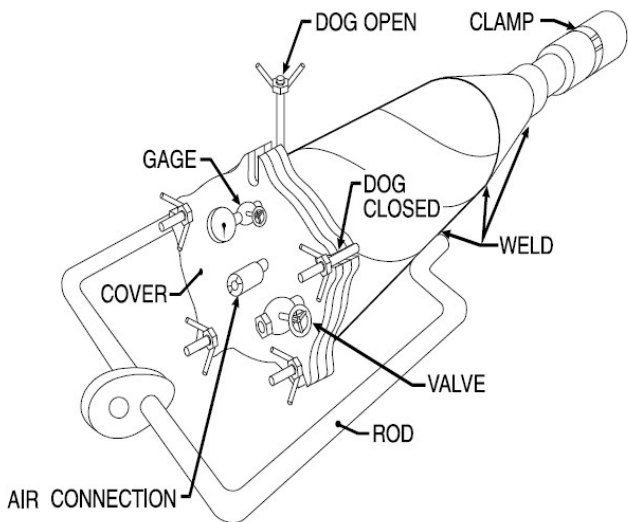

Figure 5-10. Cement Gun.

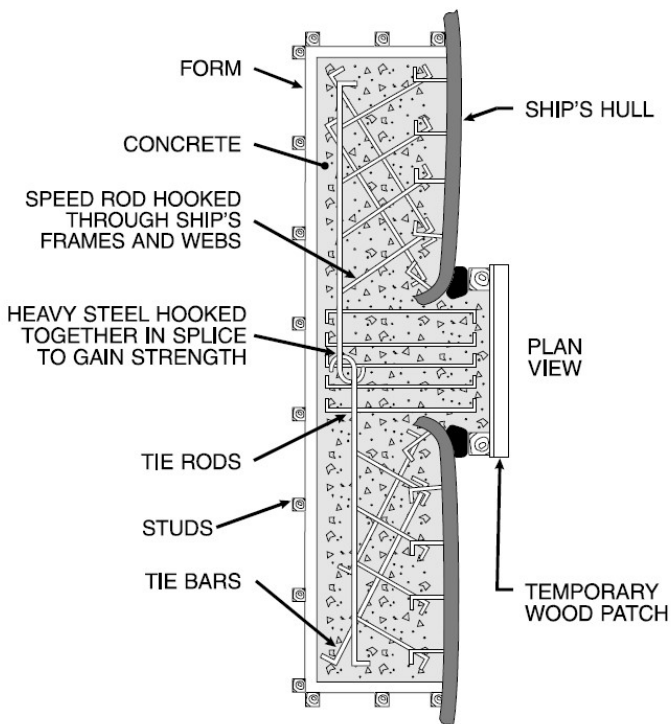

Figure 5-11. Large Reinforced Concrete Patch.

5-2.10.1 Concrete Patch Design

When building a concrete patch:

- Extend patches to fully cover the damaged area, overlapping onto undamaged hull on all sides of the hole.
- Use strong, watertight and adhesive concrete when applying to steel.
- Free hull surfaces of oil, paint and grease to aid bonding. Rusty surfaces bond well.
- Use concrete in both wet and dry compartments.
- When water pressure prevents pouring, pump concrete

- underwater with a concrete gun or pump into a prefabricated form.
- Weld reinforcement bar to the hull and weave it through the form to ensure concrete adhesion. Extend rebar at least six inches to one foot past any sections of bent hull.
- Wire mesh and steel shapes add tensile strength to concrete.
- Determine the reinforcement depth to estimate the concrete thickness. Measure the hole's indentation depth and add six inches.

5-2.10.2 Concrete Holding Power. Concrete's underwater weight determines holding power.

Table 5-1. Mixed Concrete Weights.

Mix	Dry lb/ft ³	Wet u/w lb/ft ³
Cement and Sand or Stone	144	80
Slag	130	66
Cinder	100	36
Rebar	150	86

5-2.10.3 Concrete Mixture

Mix concrete in the following proportions:

- Portland cement - 1 part
- Sand - 1-1/2 parts
- Gravel or crushed rock - 1-1/2 to 2 parts
- Water - 4 to 6 gallons per bag of cement. Keep to a minimum in concrete used underwater. Add just enough water for a thick, homogeneous mixture.

5-2.10.4 Placing Concrete. In a dry compartment, pour the concrete directly into the form. Place concrete in a flooded space by:

- Diver positioning of concrete-filled sand bags. Bags should be porous enough to allow cement seepage for binding.
- Loading the concrete directly into the form by using a tremie, a large-diameter pipe with a funnel-shaped top, designed to facilitate loading concrete into the pipe.
- Spraying concrete into the form with a cement gun. Good for forcing concrete into voids, sea chests and pipes when water pressure prevents free flow.
- Passing in buckets by divers.
- Pumping into a form with a pressurized grouting pump unit.

Stop water from flowing around temporary patches to keep pockets from forming between the hull and concrete. Pockets fill with water and crack under hydrostatic pressure. Cracking causes leakage through a patch.

Stop pocketing with a drain pipe run from the hole's bottom through the concrete. Thread the pipe discharge end or fit with a valve. Pour concrete into a form in a compartment under air pressure with the same arrangement. Air, not concrete, passes through the pipe and out the hole.

5-2.10.5 Concrete Form Design. Use forms to hold concrete while it hardens. Shore the form to resist hydrostatic pressure and to hold the concrete's weight.

- Use forms in dry and wet environments.
- Forms should not allow water flow through the concrete. Water flow carries away cement, resulting in insufficiently hardened concrete.
- Avoid excess water that causes laitance, fine-particle accumulation on the fresh concrete surface, caused by excess water moving upward. Laitance hardens very slowly and prohibits new concrete from bonding.
- Temporarily dewatering spaces aids form construction.

5-2.10.6 Concrete Form Construction. Wood is the most common material used in forms.

- Build forms strong enough to hold the concrete volume.
- Install shoring to keep the form secure against movement.
- Weld reinforcement bar to protrude from the hull into the form to keep the form and concrete from moving.

5-2.10.7 Large Concrete Patches. Construction requires additional reinforcement bars or wire mesh to aid bonding to the hull and resist bending moments caused by sea action against the hull.

5-2.10.8 Shoring Concrete Patches. Shore concrete patches used as ballast to inhibit movement in a seaway. Paragraph 5-3 discusses shoring techniques and design.

5-2.11 Sealants.

Epoxies, silicone rubber and asphalt-based and glass-reinforced-plastic compounds can be used to seal or caulk wooden plugs, wedges and small steel patches. These compounds close very small openings and leaky hull fittings that cannot be spot-welded or plugged by other methods. They are good for final seals around large wood or steel patches and for binding wedges into a single compact mass.

5-2.12 Box Patches

Use box patches to cover holes of all sizes. The modified American patch for large holes can be complex to design and install.

5-2.13 Built-up Patches

The built-up, plate-on-plate, or plank-on-plank patch is a series of narrow strips, steel plates, or wooden planks laid across the damage. Each plank or plate is fixed in place individually. These patches are custom-built for the damage. Unlike box patches, their installation may require a lot of diving time.

5-2.14 Marking Patches. To alert tug and boat operators to avoid the areas of patches, mark the location of patches below the waterline with the warning “**PATCH BELOW**” in a color that contrasts sharply with the hull.

5-3 SHORING

Refs: *NSTM, Chpt 079; DC 3 & 2, Chpt 7; SAL ENG*

Shoring prevents structural failure, strengthens weak or repaired areas and supports temporary patches and bulkheads.

Strongbacks between the shore ends and the structure distribute loads over a large area. Wedges driven between the shore and strongbacks keep the shoring tight and in place.

5-3.1 Shoring Materials. Shipboard shoring material is usually rough-cut, unpainted lumber. Use straight-grained, knot-free wood for shoring.

Navy ships carry adjustable steel shoring with screw jacks and ball-and-socket end fittings. Metal shores are stronger than wooden shores, fireproof and time-saving. Make rapid shore length adjustments by turning the screw ends. Measuring and sawing steel shores to fit is not necessary. Procedures for wooden shores also apply to steel shores. It is common to use wood and metal shoring together.

5-3.2 Compensating Buoyant Shoring. Weight wooden shoring to offset buoyancy to enable easier underwater handling or to prevent shores from floating out of position. If buoyancy holds the shoring in place, remove weights after the shoring is complete. Leave weights in place if the buoyancy pulls the shoring away from its intended position. The amount of weight required to neutralize the wooden shores is determined by:

$$W = VB$$

where:

W = amount of weight to add to neutralize shoring piece

V = volume of wood in cubic feet determined by (l)(h)(w)

B = net buoyancy in pounds per cubic foot found in Table 7-12.

5-3.3 Shoring Guidelines. General guidelines are:

- Shore length should not exceed 30 times the shore's minimum thickness. The lower the ratio of length-to-thickness, the stronger the shore.
- Wedges are the same width as the shore and six times as long as their butt width.
- Shores are at least one inch thick and larger than the shore butt surface.
- Strongbacks are the same size as the shore and long enough to span two or more stiffeners.

5-3.4 Shore Strength. A shore supports the greatest load when in direct compression or when the pressure is co-axial with the grain. Shores provide little or no support under cross-axial force. General guidelines to improve shoring strength:

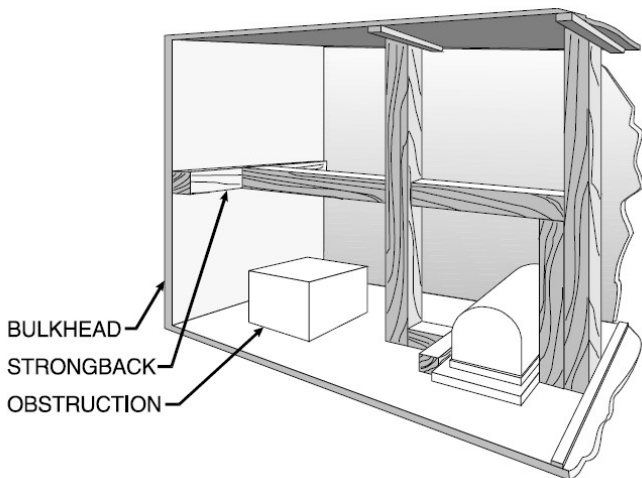
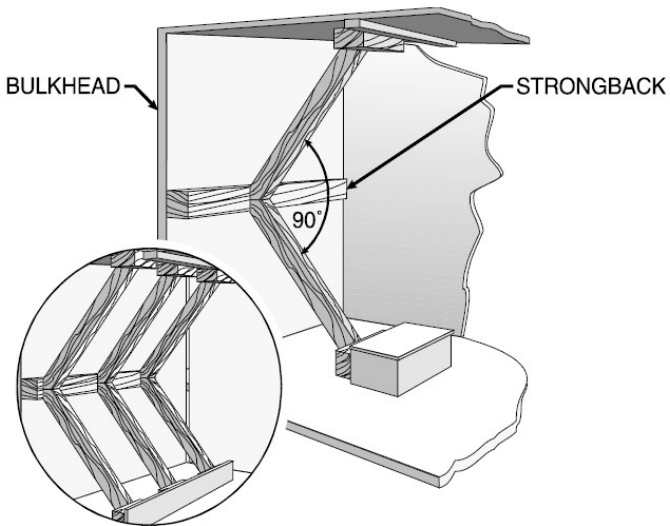

Figure 5-12. Direct Compression Shoring.



THE USUAL METHOD
OF INSTALLING
SHORES IS BY A
TRIANGULATION
SYSTEM

Figure 5-13. Triangulation Shoring.

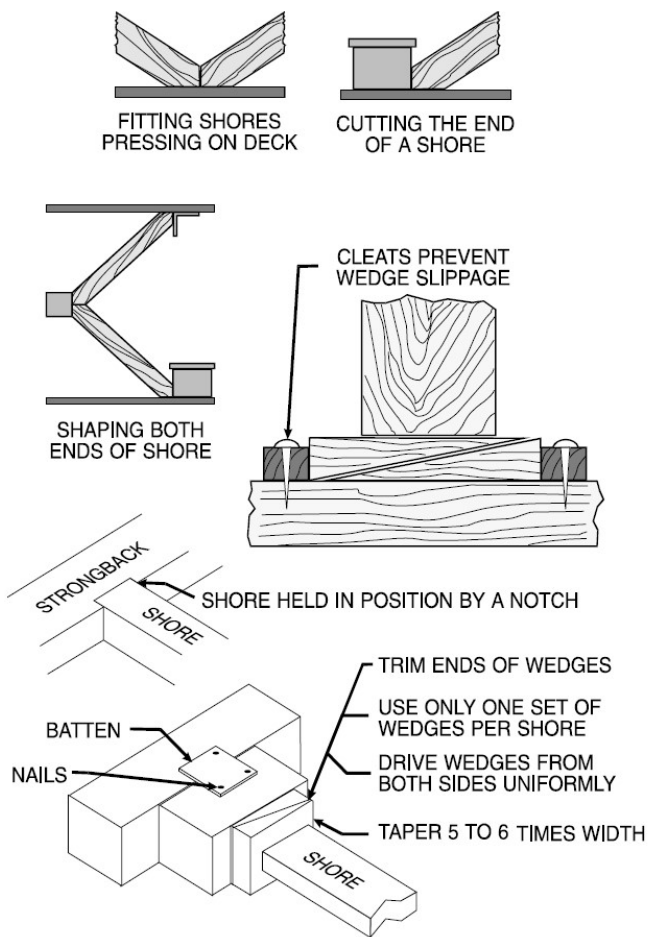
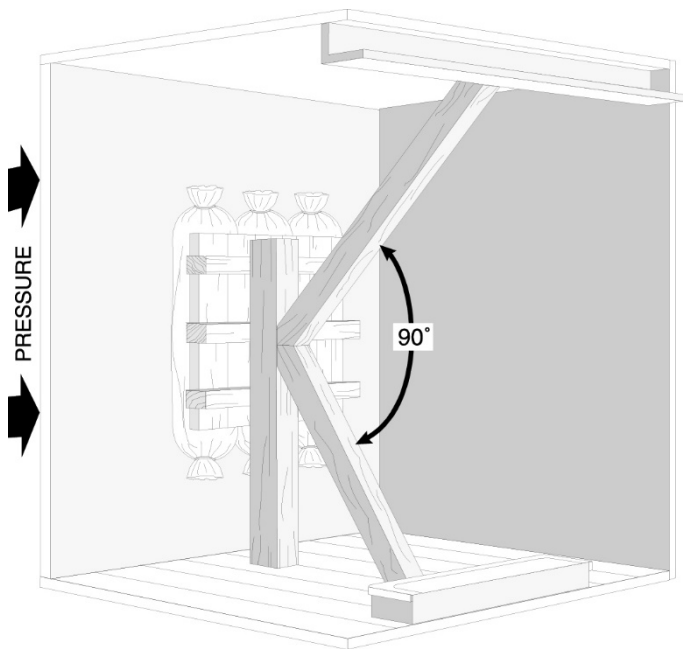

Figure 5-14. Anchoring Shores.



K-SHORE

Figure 5-15. Shoring to Resist Hydrostatic Pressure.

- Maximum angle between shores should be 90 degrees. Angles larger than this decrease shore strength
- Strongbacks direct the load against structurally sound points. They distribute pressure to reduce the damage caused by pressure concentrated against a single point.
- Toe-nailing supporting shores strengthens long shores and helps resist bowing.
- Use wedges in pairs, drive simultaneously and cleat. Sand or metal filings on wedge faces increase holding power.

5-3.5 Shoring Patches. Support external patches having large surface areas with strongbacks and shoring from dewatered

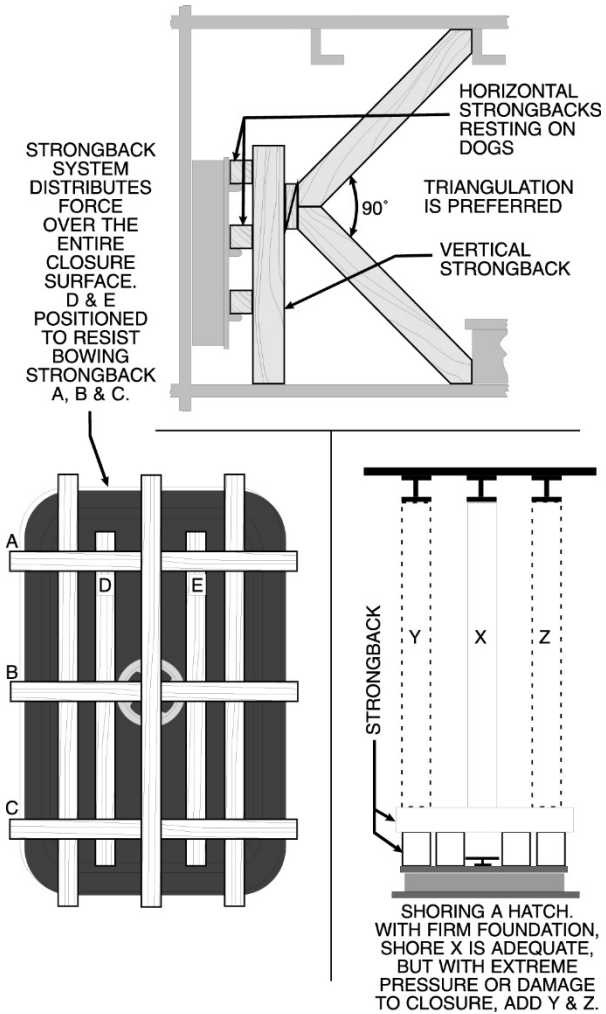

Figure 5-16. Shoring Doors and Hatches.

compartments inboard of the patch. Hold internal patches in place against hydrostatic pressure with shoring.

5-3.6 Shoring Doors and Hatches. Place strongbacks across all dogs. Shore additional pressure points if there is damage.

5-4 DEWATERING

Refs: *NSTM, Chpt 079; SALMAN, VOL 1; SAL ENG; ESSM CAT*

Dewatering restores buoyancy to a sunken or partially sunken ship. This section addresses dewatering with pumps, compressed air and water replacement.

5-4.1 Pumping. Pumping is the preferred dewatering method. Advantages are:

- It is relatively easy to rig and use.
- Compact, portable equipment moves large volumes of water with a high degree of efficiency.
- Water level control and dewatering rate are precise.
- It requires less preparation and set-up time than other methods.
- Patching externally for pump operations is usually easier and safer than patching internally.

5-4.1.1 Pump Theory. Base pumping rate on head pressure. Head is the measure of pressure exerted by a liquid column caused by the liquid's weight. Express pumping head in feet of seawater. Determine total head in Fig 5-17 by:

$$H_t = H_s + H_d + H_f$$

where:

- H_t = total head in feet of seawater
- H_s = static suction head (suction lift) - vertical distance between the liquid surface and the pump suction inlet
- H_d = static discharge head - vertical distance from the pump to the free discharge point or to the discharge tank's liquid surface

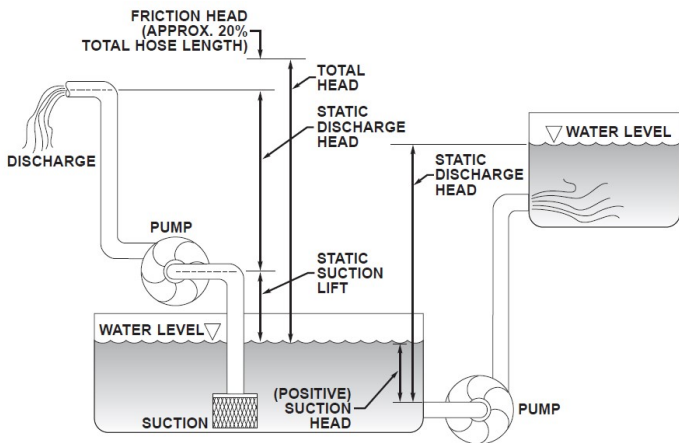

Figure 5-17. Pumping Heads.

H_f = friction head - total friction loss caused by pumping the liquid through pipes, hoses, valves and pump fittings (H_f is about 20% of the total length in feet of suction and discharge hose or pipe)

Reduction in pumping capacity is noticeable at lifts of more than 15 feet and very pronounced at 25 feet.

5-4.2 Pump Types. A number of different pumps are in use in the Navy today.

5-4.2.1 Navy Diesel Salvage Pumps

All U.S. Navy diesel salvage pumps are self-priming and can re-prime with a 25-foot suction head. Pump size is measured by the suction diameter or discharge port. Standard Navy diesel

pumps are 3-, 6- and 10-inch. These pumps operate at inclinations of up to 15 degrees and pass spherical objects up to 25 percent of the pump size. See Figs 7-4A through 7-4P regarding pumps and pumping curves.

5-4.2.2 Navy Electric Submersible Pumps. U.S. Navy electric submersible pumps offer high capacity at large heads. Zero suction head eliminates suction hose problems. Submersibles are lightweight, easy to handle and rig and instant-starting. Interchangeable impellers allow lifting liquids of various viscosities. Electric submersibles range from 1-1/2 to 4 inches. See Paragraph 7-5.

The Navy standard 4-inch electric submersible pump is made in two models. Model number 9-26034-161 has been modified for pumping POL and may be used safely for this service. **Do not use pump model 25034B for pumping POL, because that pump has not been modified.**

5-4.2.3 Navy Hydraulic Submersible Pumps. These 1-1/2-, 5- and 6-inch POL transfer pumps are also used for salvage dewatering and are drawn from the ESSM system. See Para 5-4.3 and Table 7-15.

5-4.2.4 Other Navy Pumps. Miscellaneous pumps include:

- 2-1/2-inch, self-contained, diesel-engine-driven, high-pressure, centrifugal jetting pumps
- 4-inch water-driven eductors (peri-jets)
- 2-1/2-inch, self-contained, gasoline-engine-driven, high-pressure, centrifugal (P-250) fire pumps
- 2-1/2-inch pneumatically driven trash pumps
- Airlifts.

5-4.2.5 Installed Pumps. Casualties' installed pumps and piping systems are good for augmenting salvage pumps. Specific products such as POL are moved safely by installed systems and are preferred. Using installed pumps reduces the number of portable pumps required or eliminates them entirely.

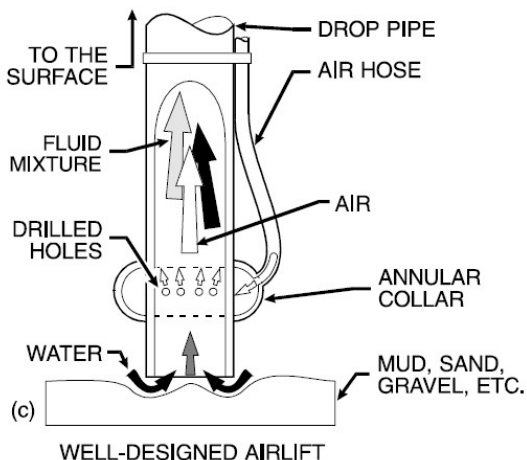
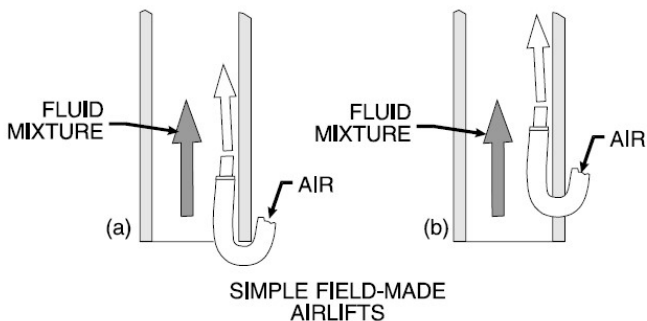

Figure 5-18. Air Lifts.

5-4.3 ESSM Pumps. ESSM bases and complexes maintain all salvage pumps in ready-to-use condition for augmenting salvage operations. The bases carry handling systems, hoses, strainers and other pump support equipment. See Table 7-15 for ESSM pumps and ancillary equipment.

5-4.4 Pumping POL Products. Pump POL products only with hydraulic or electric submersible pumps, pneumatic diaphragm pumps, or other pumps designated intrinsically safe by the U.S. Coast Guard.

NEVER pump POL products with diesel- or gasoline-engine-driven pumps.

The *SAFMAN* and *SALMAN*, VOL 2 contain guidelines and operating procedures for transferring POL products under salvage conditions.

5-4.5 Pump Requirements. Determine the minimum pumps needed to dewater a space in a given time period by:

- Calculating each pump's capacity in GPM
- Multiplying each pump's capacity by the minutes available for pumping, to determine the gallons of water each pump removes in the pumping period.
- Calculating the total gallons of water to be removed
- Dividing the total gallons to be removed by the quantity one pump can remove, to determine the minimum number of pumps required. If the resulting value is a fraction, round to the next higher whole pump.
- Use at least two more than the computed minimum number of pumps to allow for poor pump performance, failure, or calculation inaccuracies.

5-4.6 Dewatering Time. Determine the time required to dewater a space with a pump battery by:

- Determining the total battery pumping capacity in GPM
- Calculating the total water to be removed in gallons
- Dividing the amount of water to be removed by the battery pumping capacity.

5-4.7 Water Surface Falling Rate. Determine the rate at which a one inch layer of water will fall per minute by:

- Calculating the total battery pumping capacity in GPM
- Calculating a one-inch water layer's volume
- Dividing the one-inch layer volume by the pumping capacity.

5-4.8 Pumping Operations. During the pumping operation:

- Test compartment watertightness and the planned dewatering rate by running all pumps well before the dewatering phase.
- Reducing any part of the total head increases a pump's capacity.
- Limit the suction head by locating the pump close to the pumped liquid.
- Decreasing suction head produces the greatest proportional increase in capacity.
- Lead suction lines as straight as possible, with no elbows or high spots in which air can pocket.
- Reduce discharge head and friction head by cutting access holes in the hull to shorten discharge hoses.
- Keep pumps and power units level with leveling platforms.
- To decrease suction head, lower pumps as the water level drops.
- Pump in series when there is a large discharge head.
- Pump in parallel to reduce the number of discharge hoses and related friction head.
- Use pumping manifolds to reduce friction head.

- Use leaky hose only on the pump's discharge side to ensure efficiency.
- Avoid overspeeding centrifugal pumps.
- Connect portable pumps to installed bilge systems when dewatering debris-filled compartments.
- Before the casualty becomes lively, secure all pumps and discharge hoses to prevent their movement.
- Rig enough pumps to overcome patch leakage.
- Provide standby pumps to back up failing or inefficient pumps.

5-4.9 Dewatering with Compressed Air

Dewatering with compressed air should be carefully planned and executed, because air:

- Involves more expense, time and energy than pumping
- Affords less salvor control and can collapse bulkheads
- Causes hulls dewatered with compressed air to rise very rapidly once positively buoyant.

5-4.9.1 Compressed Air Use. Compressed air should be used when:

- Dewatering large tanks, spaces or entire ships with holed bottoms that are inaccessible for patching
- Dewatering when bottom damage is extensive
- Floating a sinking ship on a bubble
- Dewatering flooded double-bottom tanks and deep tanks open to the sea
- Dewatering a capsized ship intended for disposal
- Dewatering tankers

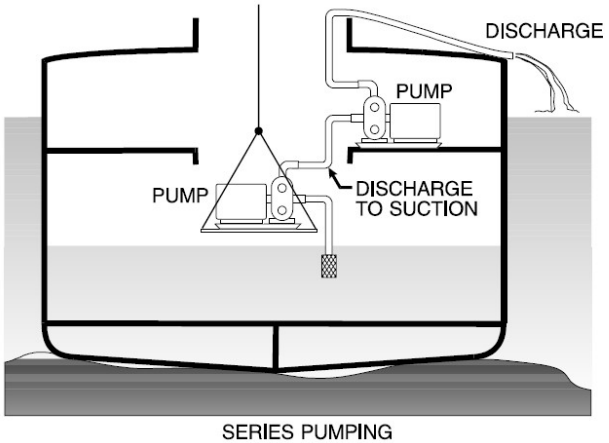

Figure 5-19A. Pumping Arrangements.

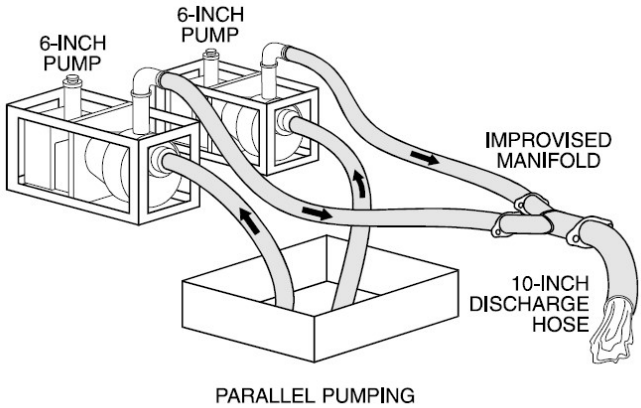

Figure 5-19B. Pumping Arrangements.

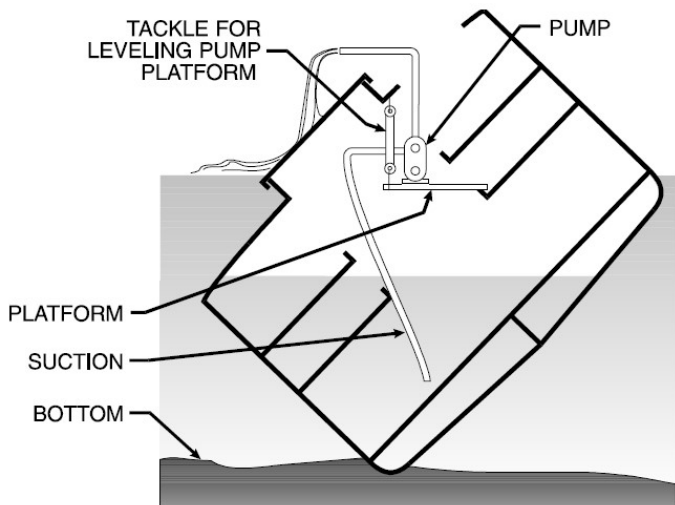

Figure 5-19C. Pumping Arrangements.

- Reducing pressure differential across decks or bulkheads
- Refloating ships on their sides or upside down
- Overcoming suction or discharge head limitations.

Do not overpressurize bulkheads. The typical shipboard bulkhead is capable of withstanding a differential pressure of 10 psid.

5-4.9.2 Air Dewatering Systems

Basic components in the system include:

- Air supply
- Blowing fitting and valve
- Compartment gage
- Water escape route through the compartment bottom or a standpipe.

Preparations include:

- Making the compartment top and vertical sides water-tight.
- Cutting water escape holes low in the compartment or installing standpipes. Damage holes are usually sufficient for water to escape.
- Rigging high-capacity air compressors, blowing fittings, hoses, manifolds, relief valves and gages.

5-4.9.3 Compressed Air Calculations

Determine the air, in standard cubic feet (SCF), required to dewater a space with a volume in actual cubic feet (ACF):

$$SCF = ACF \times \frac{(D + 33)}{33}$$

where:

SCF = air in cubic feet required to fill the space

ACF = compartment volume in actual cubic feet

D = water depth in feet

Additional corrections for air/water temperature differentials can normally be ignored.

5-4.9.4 Compressor Requirements

Determine the minimum compressors to dewater a space in a given time by:

- Calculating the air in standard cubic feet (SCF) required to dewater the space
- Dividing SCF by the desired dewatering time. This calculation gives the total standard cubic feet per minute (SCFM) required.
- Dividing SCFM by the compressor's rating gives the number required. If the result is a fractional value, round to the next higher whole number.

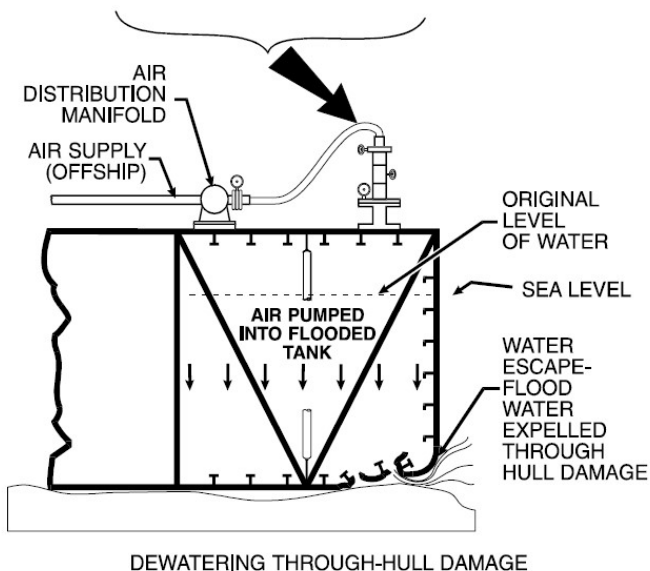
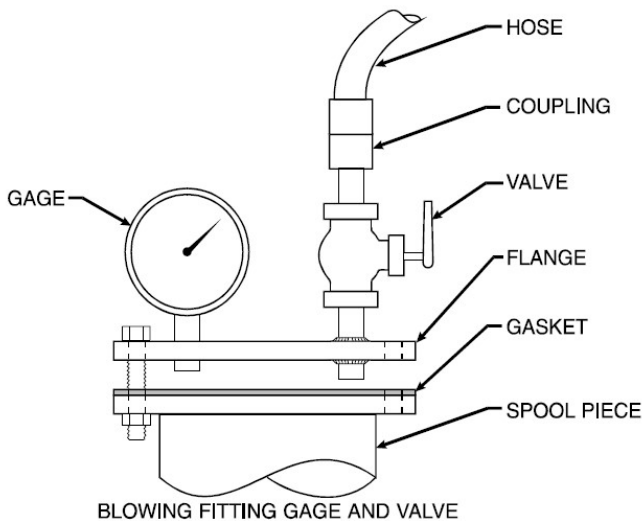
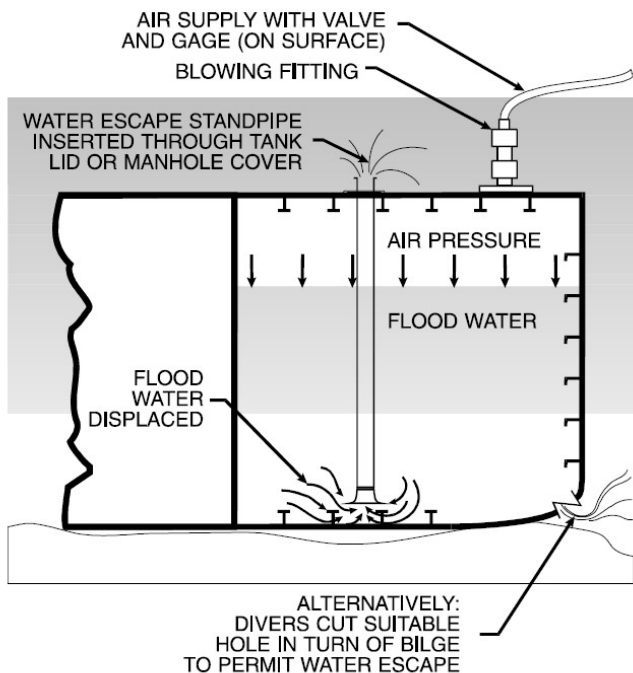

Figure 5-20A. Blowing Techniques.



DEWATERING A CLOSED COMPARTMENT

Figure 5-20B. Blowing Techniques.

5-4.9.5 Dewatering Time

To determine the time to dewater a space with a given number of compressors:

- Calculate the volume required to dewater the space in standard cubic feet (SCF).
- Calculate the total air compressor capacity in SCFM.
- Divide SCF by SCFM for dewatering time in minutes.

5-4.9.6 Air Compressor Operations

General guidelines include:

- Mount air compressors off the ship if practical.
- Use air delivery manifolds for single-point control.
- Distribute air through installed piping systems.
- Install internal indicators to show water level changes.
- Mark all air hoses to indicate their destinations.
- Internal leakage can cause buoyancy increase or decrease in unwanted areas.
- Air volume drives more water than high air pressure.
- A ship refloated upside down is usually more stable than the same ship floating upright.
- Avoid compartmental air pressure buildup by using large water escape openings or standpipes.
- Install pressure relief valves to avoid catastrophic bulk-head failure because of air expansion in a rising ship.

5-4.9.7 Air Dewatering Hazards. When using air dewatering techniques:

- Counter pressure differentials between flooded and dewatered spaces with shoring to prevent space boundary collapse.
- Pressure changes can unseat patches.
- Analyze stability carefully before refloating a vessel with many large tanks and inherent free surface.
- Compressed air migrates to the high side through small holes or breaches in the internal structure.
- **A ship with a slight list can develop a major list quickly if compressed air is shifting through longitudinal bulkheads.**

5-4.10 Compressed Air and Pump Combinations. Air pressure produces a positive suction head that improves pump performance. It may maintain the pressure differential across bulkheads within limits.

- Avoid excessive pressure differentials after dewatering a compartment. Where water is blown to the atmosphere, there is atmospheric pressure on the bulkhead's internal side and hydrostatic pressure on the external side.
- Double patch all holes because reversible pressure differentials are likely to be encountered.
- Avoid excessive or insufficient internal pressure.

5-4.11 Water Displacement. Dewater compartments by replacing the water with buoyant objects or mass. Buoyant objects such as sealed drums, pontoons and lift bags should have large buoyancy in relation to their own weight. Mass buoyancy systems are usually expensive, complex and require excessive amounts of equipment.

5-4.12 Pumping Plates. Good for dewatering ships with only four to six feet of water over the decks. Plates act the same as a cofferdam. Construct and attach to a hatch or scuttle coaming similar to patches or modify an existing tanktop access cover. Connections through the plate include:

- Pump suction or submersible discharge standpipes
- Air venting standpipes doubling as a soundingpipe
- Personnel access trunks that double as a pump opening
- Power leads for electric submersibles.

In operating with pumping plates:

- Monitor the air vent. Blockage or accidental closure could cause a vacuum.
- Provide a means for sounding the space.
- Rig submersible pumps to discharge water through a cofferdam built into the pumping plate.

5-5 COFFERDAMS

Ref: *SALMAN, VOL 1; SAL ENG; Underwater Cut and Weld*

Cofferdams extend a compartment's or ship's freeboard above the high water level to facilitate dewatering. Cofferdams are small, partial, or full. Whatever type is used, construct cofferdams with enough strength to withstand significant loads, currents, wave action and hydrostatic pressure.

5-5.1 Small Cofferdams. For personnel access or pumping spaces with small openings covered by water. Easy to construct and install with common materials.

5-5.2 Partial Cofferdams. Extend hatches and deck openings above the high water level but are time-, labor- and engineering-intensive. Decks are subjected to hydrostatic pressures as the level drops below the cofferdam. Require significant internal shoring carried to the bottom.

5-5.3 Full Cofferdams. Extend the entire ship's sides above the high water level. Not good for raising ships in areas open to the sea. Time-, labor- and engineering-intensive. Good for ships with many deck openings.

5-5.4 Cofferdams and Stability. Cofferdam structures added to the submerged ship's topside reduce stability during the pumping operation. The greatest instability occurs:

- As the ship comes off the bottom
- Just before pumping out all of the water.

General guidelines are:

- Instability can be greater with a partial cofferdam than a full cofferdam because of the large waterplane area differential.
- Install enough flood valves in a cofferdam to allow rapid flooding if necessary to regain stability.
- Complete a stability analysis before dewatering.

THIS PAGE INTENTIONALLY LEFT BLANK

6-1 INTRODUCTION

Ref: *TOWMAN; SAL ENG; NSTM Chap 582*

The Commanding Officer assigned to take the refloated ship in tow is responsible for seaworthiness and safe towing rigging. This chapter discusses tow preparations aboard the stranded ship before retraction. It also provides quick reference for checking proper rigging materials and techniques for single tug tows.

Close coordination between the salvor and towing ship is important, because materials for rigging a stranding for tow are not always available. It is often necessary to use makeshift towing attachment points. Substitute chain, stoppers, and wire rope can be used for a towing bridle. Conform to App H, TOWMAN requirements whenever possible. Refloated ships usually require a riding crew to operate equipment to keep the ship afloat and to check the tow bridle.

6-2 ATTACHMENT POINTS

Use existing tow attachment points after thorough inspection. Most Navy ships have a free-standing padeye on the forecastle for securing the towing bridle to a chain stopper. Most commercial ships have horizontal padeyes for installing chain stoppers or Smit towing brackets.

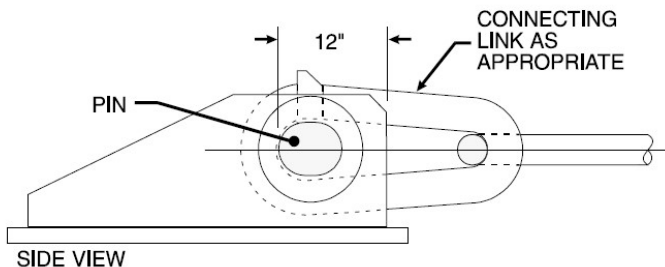

CHAIN SMALLER THAN 3-1/4" WILL REQUIRE
A PEAR-SHAPED LINK OR AN ANCHOR SHACKLE TO
CONNECT TO THE STANDARD SMIT BRACKET

Figure 6-1. Smit Towing Bracket.

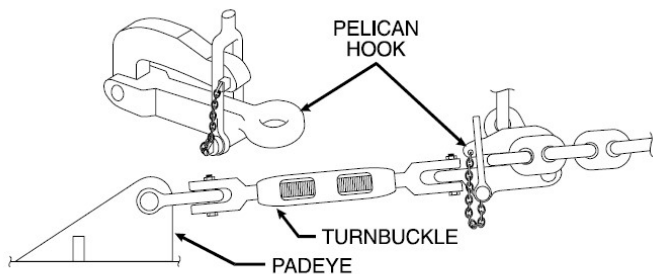

Figure 6-2. Chain Stopper.

Figure 6-2. Chain Stopper.

6-2.1 Emergency Attachment Points. Use emergency tow points as necessary. Rig with an integrated attachment point and avoidance of towline chafing in mind.

Emergency attachment points are:

- Anchor chain. Stop off anchor and break chain. Lead chain from deck chain stopper through bullnose or deck edge chock. **Do not tow on the windlass brake.** Veer enough to chafe the chain and not the topline.
- Anchor chain through hawsepipe. Remove anchor and connect topline to anchor chain. Stop chain on deck. **Do not tow on windlass brake.** Veer chain to desired length through hawsepipe.
- Chain to foundations. Pass anchor chain around gun or winch foundations. Lead chain or wire pendant forward through bullnose or deck edge chock to topline.
- Wire around bitts. Bitts should have enough SWL to withstand towing forces. Loop a wire strap around a set of bitts and connect to topline. Use backup bitts whenever available. Take one turn on forward bitts and *figure-eight* turns on the secondary bitts to spread the load evenly. Exceeding one turn on the forward bitts allows only 6 to 12 percent of the load to pass to the second bitts.
- Chain around bitts. **If possible, avoid *figure-eighting* chain around bitts because shock loading from sudden rendering can lead to spontaneous chain failure.**
- Fabricated deck padeye. Manufacture and weld in place to provide a suitable attachment point.

Table 6-1. Steel Bitt SWL.

Bitt Size (Diameter)	SWL (One barrel, any direction)
4 inch	23,000 lbs.
8 inch	60,000 lbs.
10 inch	100,000 lbs.
12 inch	164,000 lbs.
14 inch	265,000 lbs.
18 inch	375,000 lbs.

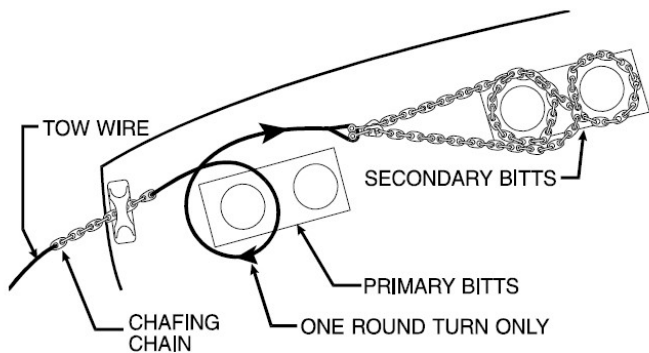

Figure 6-3. Sharing Towing Load Between Bitts.

6-2.2 Padeye Design Using Figure 6-4

Use of this method yields a minimum safety factor of 3 for all failure modes. If a padeye failure load of 240,000 lbs is desired, use 80,000 lbs as the design load (F).

1. Estimate towline tension or load (F) and choose a plate thickness (t).
2. Find intersection point for load (F) and plate thickness (t).
3. Draw a vertical line from the intersection point in 2 above to determine minimum hole diameter (d).
4. At the intersection of the vertical line drawn in 3 above with the upper broken line, draw a horizontal line to determine the distance from the hole to the edge of the plate (L). This minimum distance applies in all directions around the hole including above and below the hole.
5. To determine the minimum length (l) for the padeye, choose a thickness for the fillet weld (T). Where the thickness (T) (lower broken lines) intersects with the load (F), draw a vertical line that intersects with the length axis (l).

Example:

Towline tension or load (F) = 80,000 lbs

Plate thickness (t) = 1 ½ inches

Diameter of hole (d) = 2 ¾ inches

Distance to edge (L) = 4 inches

For fillet welds ½-inch thick

(T) Padeye length (l) = 16 inches

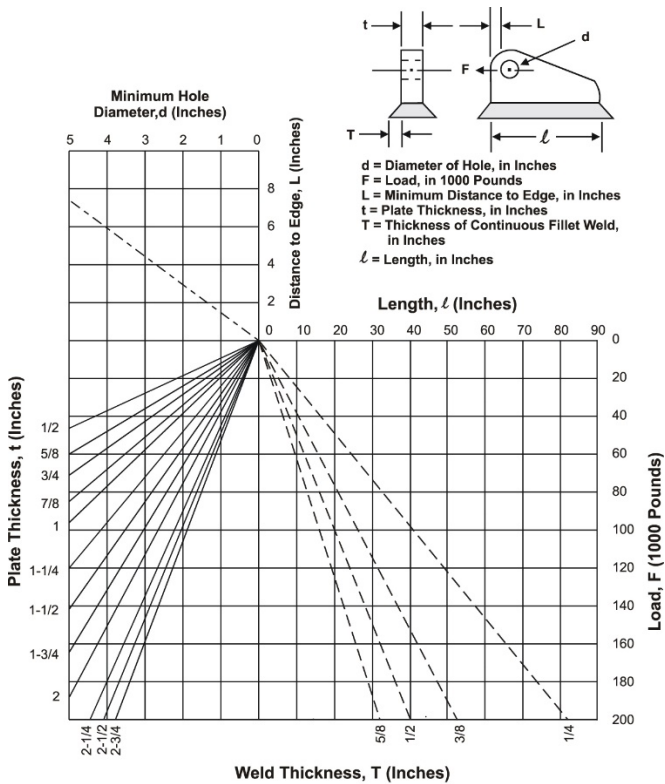

NOTE
Padeye material should be ASTM-36, ABS Grade A

Figure 6-4. Minimum Padeye Design Requirements

6-3 GENERAL TOWING RIG INFORMATION

Ref: *TOWMAN; SAL ENG; NSTM Chap 582*

Towing rigs are single elements or two-legged bridles. The type to use depends upon ship type, attachment points, chain and wire availability, deck power required for heaving chain around, etc.

Both pendant and two-legged bridles should attach to a lead chain or wire pendant that connects to the towline.

Install the towing rig so that it is as similar as possible to the designed system.

General tow rig information includes:

- Towing rigs should include chain to eliminate tow wire, wire bridle, or wire pendant chafing at the deck opening or bullnose. When chain is not available, use heavy wire rope and install chafing gear at appropriate points.
- Rig a retrieval pendant of sufficient strength to lift both bridle and lead pendant weight.
- Design the towing rig for quick release.
- Inspect chain as in Para 3-4.5.

Determine the tow rig weak link before starting the tow. **Weak link BS should be 10 to 15 percent lower than towing hawser BS to protect the tow wire. It should be placed between the flounder plate and tow wire.**

6-3.1 Pendant or Single Leg Rig

Single-leg towing rigs are the simplest for towing ships with fine lines, bulbous bows, sonar domes and emergency towing. Lead a single chain or heavy wire rope chafing pendant from the towing padeye through the bullnose to the towing hawser.

Para 6-2.1 discusses alternate pendant attachment points when towing padeyes are not installed.

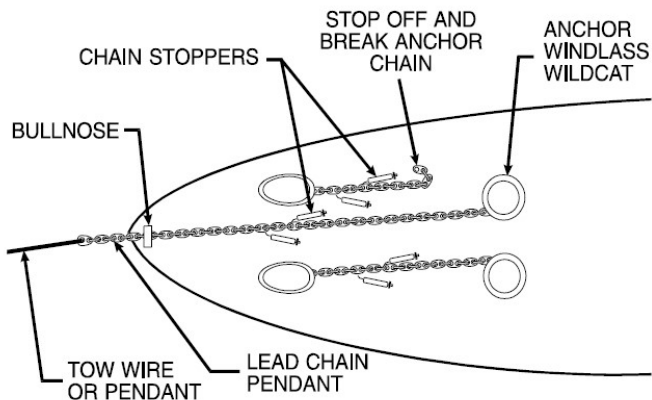

Figure 6-5. Pendant or Single-Leg Rig.

6-3.2 Chain Bridle or Double-Leg Rig

Two-legged bridles consist of chain or heavy wire rope equal in length to the towed ship's beam. Two legs are attached at the apex to a flounder plate forward of the bow. The lead chain or pendant connects from the flounder plate to the towline. A retrieval wire leads from the flounder plate to the towed ship's forecastle.

Bridle rigs may chafe on the bow more than a single-pendant rig if the tow does not track directly astern. Chafing can part bridle rigs over a long period. Bridle rigs are useful for towing ships or barges with blunt bows.

6-3.3 Lead Chain and Wire Pendant. Lead chain is an extension between the towing pendant or bridle and towline to add weight to the system. This adds weight or spring to absorb sudden towline shock. Refer to *TOWMAN*.

Long lead wire rope pendants permit towline connection on the tug's stern. The pendant is shackled between the bridle or lead chain and tow wire.

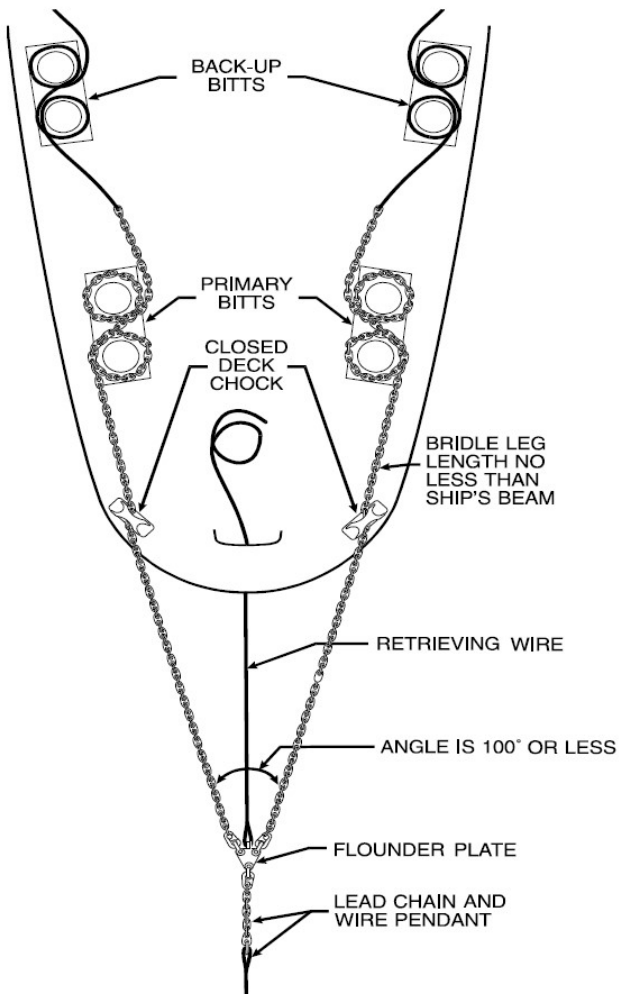

Figure 6-6A. Chain Bridle or Double Rig.

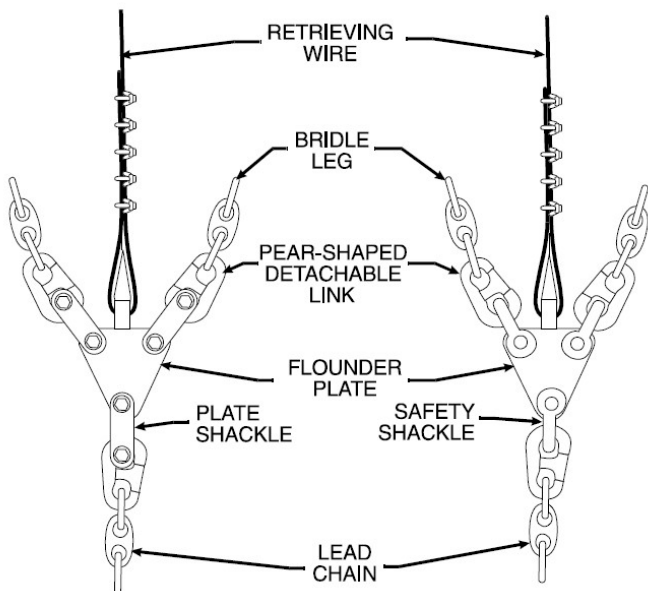

Figure 6-6B. Flounder Plate Connections.

6-3.4 Bridle Chain Specifications. Navy Stud-Link and Di-Lok chain characteristics are found in Table 3-11A through D. Navy Stud-Link is equal to commercial Grade 3.

Baldt Di-Lok chain is 11 percent stronger than Navy Di-Lok chain. Grade 3 chain is 3 percent stronger than Navy Standard Di-Lok. Grade 2 is 72 percent and Grade 1 is 51 percent of Di-Lok strength.

6-3.5 Connecting Hardware. Use proper size detachable chain links for connecting the tow wire to the lead chain or single-leg pendant. Other connectors include chain stoppers, plate shackles, safety shackles, flounder plates and end fittings.

Chain stopper and padeye breaking strengths are 60 percent of breaking strength of the same size chain.

6-3.6 Synthetic Line. Synthetic line, acting as a spring between the lead chain and tow wire, mitigates dynamic loading. The spring is normally 200 to 400 feet in length. Use a safety factor of 14 to determine the spring size. This accounts for the 15 per-cent reduction in strength for wet nylon and the grommet. See *TOWMAN* regarding synthetic lines.

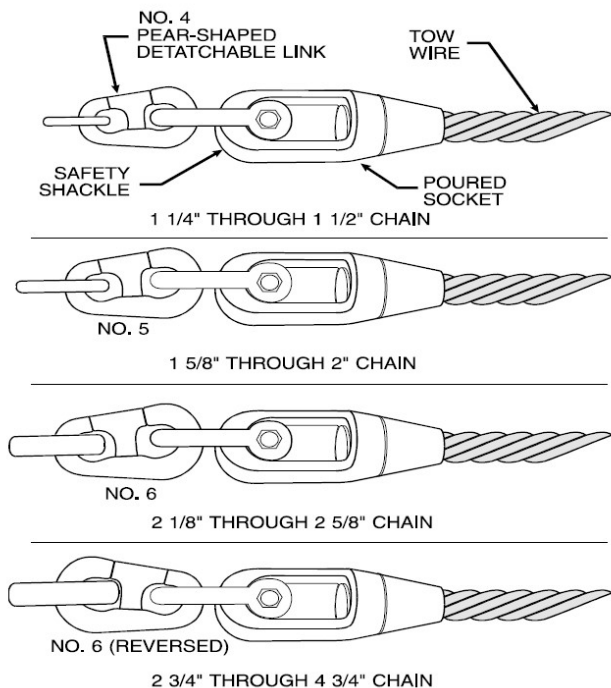

Figure 6-7. Towline Connections.

6-3.7 Backup Towing System. Install a secondary towing system before taking the stranded ship in tow. Secure the towing pendant or bridle to a hard attachment point. Stop off the secondary lead pendant over the side. Stream an attached light floating messenger and marker buoy astern for easy recovery.

6-4 ANCHORING

The towed ship must have an anchor ready for letting go in case the tow wire parts. The anchor chain or wire must be long enough to allow veering to at least 3-to-1 scope in water at least 50 feet deeper than the ship's draft.

6-5 TOWING BRIDLE CHECKOFF LIST

Ref: *TOWMAN*; *SAL ENG*; *NSTM Chap 582*

Use Table 6-2 as a guide to check the stranding's towing bridle.

TABLE 6-2 is not a substitute for *TOWMAN* requirements.

Catenary calculation procedures are found in Para 7-7.3

Table 6-2. Stranded Ship Towing Bridle Checkoff List

1.	Inspect or test tow attachment points.....
2.	Measure all bridle and pendant chain for elongation
3.	Check bridle legs for same size chain and equal lengths
4.	Check bridle for adequacy. No less than 1¼ inches, and no more than 2¼ inches for larger ships
5.	Check double rig bridle leg lengths. Distance from flounder plate to attachment points must be equal to or greater than the horizontal distance between attachment points.....
6.	Bridle apex angle should be between 30 and 60 degrees
7.	Determine if a second shot of chain is needed between the towline and bridle flounder plate for additional spring or because of high bow
8.	Check all pins in detachable links
9.	Install chafing chain at all chafe points.....
10.	Determine if emergency attachment points, fairlead chocks, and bullnose are strong enough to handle towing forces and chafing. Include backup securing system.....
11.	Check deck strength around primary and backup bits. Minimum bitt size is 4 inches diameter
12.	Ensure proper load sharing when using bits as attachment points. One turn on the forward or primary bitt and figure-eight on the secondary or backup bitt. Remove all slack from figure-eighted chain or backup wires
13.	Weld channel iron keeper bar across bits to secure wire or chain
14.	Retrieving pendant should have 4-to-1 safety factor for lifting the bridle weight, enough slack to avoid load, and proper number of wire clips.
15.	Check all tow connecting pins for clearances no greater than 1/16-inch and for at least 5/16-inch locking bolts on all plate shackles.....
16.	Check secondary towing system installation.....
17.	Will all towing jewelry pass through bullnose and fairleads if emergency disconnect is required?
18.	Identify the tow rig weak point breaking strength. This should not be the towline.....

THIS PAGE INTENTIONALLY LEFT BLANK

7-1 INTRODUCTION

This chapter contains miscellaneous information useful during salvage operations. Ground reaction is measured in long tons. Freeing and lifting forces are measured in short tons.

7-2 WEIGHTS AND MEASURES

This section lists general information needed for performing salvage calculations in both metric and English systems. Use this material with salvage formulae found throughout this manual.

Table 7-1. System of Metric Measures.

LENGTH	
1 meter (m)	= 10 decimeters (dm) = 100 centimeters (cm) = 1,000 millimeters (mm)
1,000 meters	= 1 kilometer (km)
AREA	
1 square meter (m ²)	= 1,000,000 square millimeters (mm ²) = 10,000 square centimeters (cm ²) = 100 square decimeters (dm ²)
1 square kilometer	= 1,000,000 square meters
VOLUME	
1 liter (l)	= 10 deciliters (dl) = 100 centiliters (cl) = 1,000 milliliters (ml) = 1 cubic decimeter (dm ³)
1 kiloliter (kl)	= 1,000 liters = 1 cubic meter (m ³)
1 milliliter (ml)	= 1 cubic centimeter (cc)
MASS	
1 kilogram (kg)	= 1,000 grams (g)
1 gram (g)	= 1,000,000 micrograms (μg) = 1,000 milligrams (mg) = 100 centigrams (cg)
1,000 kilograms	= 1 metric ton (tonne)
FORCE	
1 kilogram force (kgf)	= 9.807 newtons (N)
1 newton (N)	= 0.102 kgf
1 kilonewton (kN)	= 1,000 newtons = 102 kgf
1 meganewton (MN)	= 1,000,000 newtons = 102,000 kgf = 102 tonnes force (tonnef)

Table 7-2. System of English Measures.

LENGTH		
1,000 mils	=	1 inch (in)
12 inches	=	1 foot (ft)
3 feet	=	1 yard (yd)
6 feet	=	1 fathom (fm)
15 fathoms	=	1 shot of chain = 90 feet
120 fathoms	=	1 cable's length = 720 feet
6,080 feet	=	1 nautical mile (NM) = 2,027 yards
AREA		
144 square inches (in ²)	=	1 square foot (ft ²)
VOLUME		
1,728 cubic inches (in ³)	=	1 cubic foot (ft ³)
27 cubic feet (ft ³)	=	1 cubic yard (yd ³)
231 cubic inches	=	1 U.S. gallon (gal)
277.27 cubic inches	=	1 imperial gallon
42 U.S. gallons	=	1 barrel = 5.615 cubic feet
1 cubic foot	=	7.48 U.S. gallons
	=	6.23 Imperial gallons
BOARD MEASURE		
board feet	=	Length in feet x width in feet x thickness in inches: therefore:
12 board feet	=	1 cubic foot
DRY MEASURE		
1 pint	=	0.5 quart = 33.6 in ³
LIQUID MEASURE		
16 ounces	=	1 pint
2 pints	=	1 quart
4 quarts	=	1 gallon
<p>NOTE: English system dry measure and liquid measure quarts and pints are not equivalent volumes. All Imperial liquid measures are therefore larger than the corresponding U.S. measure by a factor of 277/231, or 1.2.</p>		
FORCE AND WEIGHT		
7,000 grains (gr)	=	1 pound (lb)
16 ounces (oz)	=	1 pound
2,000 pounds	=	1 short ton
2,205 pounds	=	1 metric ton (tonne) = 1,000 Kg
2,240 pounds	=	1 long ton

Table 7-3. Basic English/Metric Equivalents.

MEASURES OF LENGTH			
1 millimeter	= 0.03937 inch	1 inch	= 25.4 millimeters
1 centimeter	= 0.3937 inch	1 inch	= 2.54 centimeters
1 meter	= 39.37 inches	1 inch	= 0.0254 meter
1 meter	= 3.281 feet	1 foot	= 0.3048 meter
1 kilometer	= 0.62 mile	1 mile	= 1.6 kilometers
1 kilometer	= 0.54 nautical mile	1 NM	= 1.85 kilometers
1 kilometer	= 1,094 yards	1 mile	= 1,609 meters
1 kilometer	= 3,281 feet	1 NM	= 1,853 meters
MEASURES OF AREA			
1 square mm (mm ²)	= 0.00155 square inch	1 square inch	= 645.2 square millimeters
1 square cm (cm ²)	= 0.155 square inch	1 square inch	= 6.452 square centimeters
1 square meter	= 10.76 square feet	1 square foot	= 0.0929 square meter
1 square meter	= 1.196 square yards	1 square yard	= 0.836 square meter
1 square kilometer	= 0.386 square mile	1 square mile	= 2.59 square kilometers
MEASURES OF VOLUME			
1 cc or ml	= 0.061 cubic inch	1 cubic inch (in ³)	= 16.39 cc or ml
1 cubic meter (m ³)	= 35.3 cubic feet	1 cubic foot (ft ³)	= 0.0283 cubic meter
1 cubic meter	= 1.31 cubic yards	1 cubic yard (yd ³)	= 0.764 cubic meter
1 liter	= 61.023 cubic inches	1 cubic foot (ft ³)	= 28.32 liters
1 liter	= 0.0353 cubic foot		
LIQUID MEASURE			
1 liter (l)	= 1.057 U.S. quarts	1 U.S. quart (qt)	= 0.946 liter
1 liter (l)	= 0.264 U. S. gallons	1 U.S. gallon (gal)	= 3.79 liters
1 cubic meter	= 264.17 gallons	1 U.S. gallon	= 0.0038 cubic meter
DRY MEASURE			
1 liter (l)	= 0.908 dry quarts	1 dry quart	= 1.101 liters
MEASURES OF WEIGHT AND MASS			
1 kilogram (kg)	= 2.205 pounds mass	1 pound mass (lbm)	= 0.454 kilograms = 454 grams
1 tonne	= 1.1023 short tons = 2205 pounds	1 short ton	= 0.972 tonne = 907.2 kilograms
1 tonne	= 0.9842 long tons	1 long ton	= 1.016 tonne = 1016 kilograms
1 milligram	= 0.0154 grain	1 grain	= 64.8 milligrams = 0.0648 gram
1 gram	= 15.432 grains		
1 newton	= 0.225 pounds force	1 pound force (lbf)	= 4.448 newtons
1 meganewton	= 100.4 long tons = 112.4 short tons = 224,799 pounds	1 long ton	= 0.009964 MN
		1 short ton	= 0.008896 MN

Table 7-4. Circular or Angular Measure.

60 seconds	= 1 minute of arc	
60 minutes	= 1 degree	
90 degrees	= 1 quadrant or right angle	
4 quadrants	= 1 circumference	= 360 degrees
2π radians	= 1 circumference	
1 radian	= 180π	= 57.3 degrees

Table 7-5. Common Pressure Conversions

MULTIPLY	BY	TO OBTAIN
Feet of seawater	0.445	psi
Feet of fresh water	0.434	psi
Psi	2.25	feet of seawater
Psi	2.3	feet of fresh water
Inches of mercury	0.49	lb/in ²
Lb/in ²	2.04	inches of mercury
Atmospheres	14.7	lb/in ²
Lb/in ²	0.07	atmospheres
Atmospheres	10.0	meters of seawater

Table 7-6. Common Density Conversion

MULTIPLY	BY	TO OBTAIN
Lb/ft ³	16.02	kg/m ³
	0.01602	g/cc
Kg/m ³	0.0624	lb/ft ³
	0.001	g/cc
m ³ /tonne	35.87	ft ³ /long ton
ft ³ /long ton	0.0279	m ³ /tonne

Table 7-7. General Conversion Factors.

MULTIPLY	BY	TO OBTAIN
Atmospheres	760	mm of mercury (mm Hg)
	76.0	cm of mercury (cm Hg)
	33.9	feet of fresh water (ffw)
	34	approx. ffw
	33.1	feet of seawater (fsw)
	10	approx. meters of seawater
	33	approx. fsw
	29.92	inches of mercury (in Hg)
	1.033	kg/cm ²
	10,332	kg/m ²
	14.7	lb/in ² (psi)
1.06	tons/ft ²	
Barrels	5.615	cubic feet (ft ³)
	42	U.S. gallons (gal)
	0.159	kiloliters, cubic meters
Cubic centimeters	0.0002642	gallons (U.S.)
	0.0338	ounces
Cubic feet	28,320	cubic cm (cc)
	1,728	cubic inches (in ³)
	0.02832	cubic meters (m ³)
	7.48	U.S. gallons (gal)
	28.32	liters
	0.178	barrels (bbl)
Cubic feet/minute	0.02832	cubic meter/min (m ³ /min)
	7.48	U.S. gallons/min (gpm)
	1.43	bbl/hour
Cubic inches	16.39	cubic cm (cc)
	0.0005787	cubic feet (ft ³)
	0.00001639	cubic meters (m ³)
	0.004329	U.S. gallons (gal)
	0.01639	liters (l)
Cubic meters	61,023	cubic inches (in ³)
	35.31	cubic feet (ft ³)
	264.2	U.S. gallons (gal)
	6.29	barrels
	1,000	liters (l)
	1	kiloliters (kl)
Cubic meters/minute	35.31	ft ³ /min

Table 7-7 (Continued). General Conversion Factors.

MULTIPLY	BY	TO OBTAIN
Feet	304.8	millimeters
	30.48	centimeters
	0.3048	meters
	0.0001645	miles (nautical)
Feet of fresh water	0.0295	atmospheres
	0.8827	in Hg
	0.0305	kg/cm ²
	62.4	lb/ft ²
	0.434	lb/in ²
Feet of seawater	0.0303	atmospheres
	0.9048	in Hg
	0.03124	kg/cm ²
	64.0	lb/ft ²
	0.445	lb/in ² (psi)
Feet/second	30.48	cm/sec
	1.097	km/hour
	0.5921	knots
	0.6818	miles/hour
	0.01136	miles/min
Foot-lbs	1.355	newton-meters
	0.1383	kilogram-meters
	13830	gram-centimeters
Foot-tons (long tons)	3,036.7	newton-meters
	0.00303	meganewton-meters
	0.3	meter-tonne
Foot-tons (short tons)	2,711	newton-meters
	0.00271	meganewton-meters
	0.276	meter-tonne
Gallons (U.S.)	3,785	cubic cm (cc)
	0.1337	cubic feet (ft ³)
	231	cubic inches (in ³)
	1.2	Imperial gallons
	0.0238	barrels (bbl)
Gallons (Imperial)	0.833	U.S. gallons (gal)
Inch-Pounds	0.113	newton-meters
	1153	gram-centimeters
Kilograms	2.205	pounds

Table 7-7 (Continued). General Conversion Factors.

MULTIPLY	BY	TO OBTAIN
Kilograms/m ²	0.2048	lb/ft ²
	0.00142	lb/in ² (psi)
Kilograms/m ³	0.0624	lb/ft ³
Kilograms/cm ²	14.226	lb/in ² (psi)
Kiloliters	6.29	barrels (bbl)
	264.2	U.S. gallons
	35.31	cubic feet (ft ³)
Kilometers	3,281	feet
	0.54	miles (nautical)
Kilometers/hour	27.78	cm/sec
	0.9113	feet/sec
	0.5396	knots
Knots	6,080.2	feet/hour
	1.8532	kilometers/hour
	0.5148	meters/sec
	1.1516	statute miles/hour
	1.689	feet/sec
Liters	61.02	cubic inches (in ³)
	0.0353	cubic feet (ft ³)
	0.2642	U.S. gallons (gal)
	0.00629	barrels (bbl) (oil)
Meganewtons	100.4	long tons (lton)
	112.4	short tons
	102	tonne
	101,954	kilograms (kg)
	224,809	pounds (lb)
Meganewton-meters	329.4	foot-tons (long tons)
	368.8	foot-tons (short tons)
	102	meter-tonne
Meganewtons/meter	30.6	long ton/ft
	34.3	short tons/ft
	102	tonne/meter

Table 7-7 (Continued). General Conversion Factors.

MULTIPLY	BY	TO OBTAIN
Meters	39.37	inches
	3.281	feet
	0.0005396	miles (nautical)
	1.094	yards
Meters/second	1.944	knots
	3.281	feet/sec
	3.6	km/hour
	0.03728	miles/min
Miles (nautical)	1,853.15	meters (m)
	1.853	kilometers (km)
	6,080	feet (ft)
	2,027	yards (yd)
	1.1516	miles (statute)
Miles/hour	44.7	cm/sec
	88	feet/min
	1.467	feet/sec
	1.609	km/hour
	0.8684	knots
	0.447	meters/sec
Millimeters	0.03937	inches (in)
Millimeters of mercury	0.00132	atmospheres
	0.00435	feet of seawater (fsw)
	0.00446	feet of fresh water (ffw)
	13.6	kg/m ²
	0.0193	lb/in ² (psi)
Newtons	0.225	pounds (lb)
Newtons/meter	0.102	kg/m
	1.356	lb/ft
Ounces	0.0625	pounds (lb)
Ounces (fluid)	1.805	cubic inches (in ³)
	0.02957	liters (l)
	0.0313	quarts, liquid (qt)
	0.0078	U.S. gallons (gal)
Pounds	0.454	kilograms
	16	ounces
	4.448	newtons (N)

Table 7-7 (Continued). General Conversion Factors.

MULTIPLY	BY	TO OBTAIN
Pounds/ft ²	0.0004725	atmospheres
	4.882	kg/m ²
	0.006944	pounds/in ² (psi)
Pounds/in ²	0.068	atmospheres
	2.25	feet of seawater (fsw)
	2.3	feet of freshwater (ffw)
	703.1	kg/m ²
	144	lb/ft ²
	0.0005	short tons/in ²
	0.000446	long tons/in ²
Quarts, U.S. liquid	0.946	liters (l)
	0.0334	cubic ft (ft ³)
	57.75	cubic inches (in ³)
	32	fluid ounces
	4	gallons
Square feet	929	square cm (cm ²)
	0.0929	square meters (m ²)
	144	square inches (in ²)
Square inches	6.452	square cm (cm ²)
	0.006944	square feet (ft ²)
Square kilometers	0.3861	square miles
	0.29155	square nautical miles
Square meters	10.76	square feet (ft ²)
	1.196	square yards (yd ²)
Square miles	2.590	square kilometers
	27,878,400	square feet
Square yards	0.8361	square meters (m ²)
Tons (long)	1,016	kilograms
	2,240	pounds
	1.12	tons (short)
	1.016	tonne (metric)
	0.009964	meganewtons (MN)
Long tons/square inch	2,240	lbs/in ² (psi)
	1,574,508	kg/m ²
	1,574.5	tonne/m ²
	157.5	kg/cm ²
	15.44	meganewtons/m ²

Table 7-7 (Continued). General Conversion Factors.

MULTIPLY	BY	TO OBTAIN
Long tons/foot	1.12	short tons/foot
	3.33	tonne/meter
	3,333.7	kg/m
	32,693.6	newtons/meter (N/m)
	0.0327	Meganewtons/meter (MN/m)
Tons (short)	907.2	kilograms
	2,000	pounds
	0.8929	tons (long)
	0.9072	tonnes (metric)
	0.008897	neganewtons (MN)
Short tons/square inch	2,000	lb/in ²
	1,406,151	kg/m ²
	1,406.15	tonne/m ²
	140.62	kg/cm ²
	13.79	MN/m ²
Short tons/foot	0.8929	long ton/ft
	0.276	tonne/meter
	2,976.5	kg/m
	29,190.6	newton/meter (N/m)
	0.0292	MN/m
Tonne (metric)	0.984	long tons
	1.1023	short tons
	2,205	pounds (lbs)
	1,000	kilograms
	0.009807	meganewtons (MN)
Tonne/meter	0.3	long ton/ft
	0.336	short tons/ft
	672	lb/ft
	9,807	newtons/meter
Yards	91.44	centimeters
	0.9144	meters

Table 7-8. Power Conversion.

MULTIPLY	BY	TO OBTAIN
Horsepower	0.746	kilowatts
Kilowatts	1.3404	horsepower
BTU	778.2	foot-pounds
Foot-pounds	0.001285	BTU
BTU	0.0003930	horsepower hours
Horsepower hours	2,554	BTU
BTU	0.0002931	Kilowatt hours
Kilowatt hours	3,412	BTU

Table 7-9. Temperature Conversion.

<p>Degrees Fahrenheit (°F) = (9/5 x degrees Celsius) + 32</p> <p>Degrees Celsius (°C) = (5/9 x degrees Fahrenheit) - 32</p> <p style="text-align: center;">ABSOLUTE TEMPERATURE</p> <p>Rankine (R) = Degrees Fahrenheit + 460</p> <p>Kelvin (K) = Degrees Celsius + 273</p>
--

Table 7-10. Common Flow Rate Conversion.

MULTIPLY	BY	TO OBTAIN
Liters per second (lps)	15.83	gpm
	2.12	cfm
Liters per minute (lpm)	0.26	gpm
	0.0353	cfm
Tons seawater per hour	261.8	gal/hour
	4.36	gpm
	0.583	cfm
	0.276	lps
Tonnes seawater per hour	0.995	m ³ /hour
	4.295	gpm
	0.574	cfm
	0.271	lps
Tons fresh water per hour	0.976	m ³ /hour
	4.475	gpm
	0.598	cfm
	0.282	lps
M ³ /hour	1.016	m ³ /hour
	4.4	gpm
	0.588	cfm
	0.278	lps
	1.01	tons seawater/hour
M ³ /sec	0.98	tons fresh water/hour
	1.025	tonnes seawater/hour
	15850.2	gpm
Ft ³ /min (cfm)	2118	cfm
	7.48	gpm
	0.472	lps
	28.32	lpm
	1.714	tons seawater/hour
	1.671	tons fresh water/hour
	1.741	tonnes seawater/hour
U.S. gallons per minute (gpm)	0.00047	m ³ /sec
	1.7	m ³ /hour
	0.134	cfm
	0.063	lps
	3.79	lpm
	0.229	tons seawater/hour
	0.223	tons fresh water/hour
	0.233	tonnes seawater/hour
0.00006	m ³ /sec	
0.228	m ³ /hour	

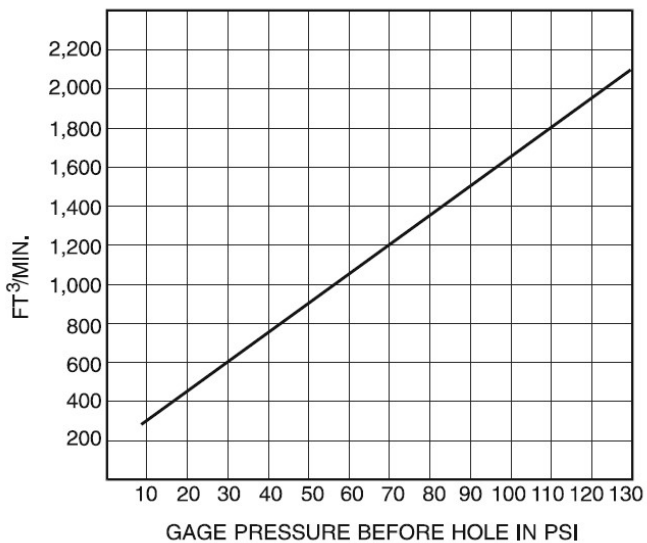

Figure 7-1. Air Discharge Through a One-Inch-Hole.

MISCELLANEOUS FORMULAS

The following formulas are useful for salvage calculations.

I_x, I_y = moment of inertia about the x, y axis.

SQUARE

$$A = a^2$$

$$a = \sqrt{A}$$

$$d = a\sqrt{2}$$

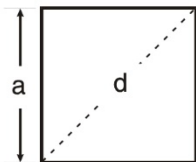

RECTANGLE

$$A = ab$$

$$d = \sqrt{a^2 + b^2}$$

$$I_y = \frac{a^3b}{12}$$

$$I_x = \frac{ab^3}{12}$$

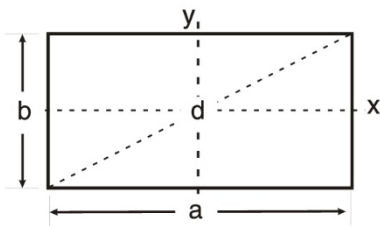

I_x, I_y = moment of inertia about the x, y axis.

TRIANGLE

$$A = \frac{ah}{2}$$

$$s = \frac{a+b+c}{2}$$

$$A = \sqrt{s(s-a)(s-b)(s-c)}$$

$$I_x = \frac{ah^3}{36}$$

$$d = \frac{h}{3}$$

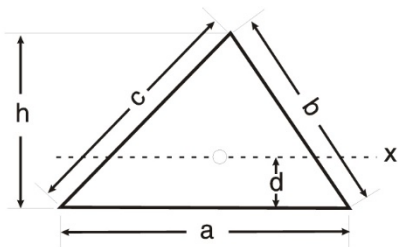

Figure 7-2A. Properties of Plane Surfaces.

PARALLELOGRAM

$$A = ah = ab \sin\theta$$

$$d_1 = \sqrt{a^2 + b^2 + 2ab \cos\theta}$$

$$d_2 = \sqrt{a^2 + b^2 - 2ab \cos\theta}$$

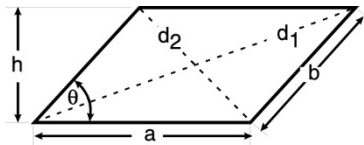

TRAPEZOID

$$A = \frac{a+b}{2} h = mh$$

$$I_x = \frac{h^3(a^2 + 4ab + b^2)}{36(a+b)}$$

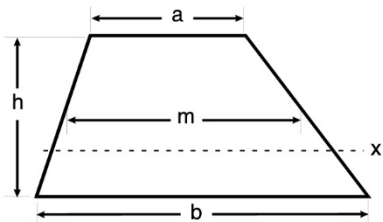

CIRCLE

$$A = \frac{\pi d^2}{4}$$

$$A = .785d^2$$

$$C = \pi d$$

$$I_x = I_y = \frac{\pi d^4}{64}$$

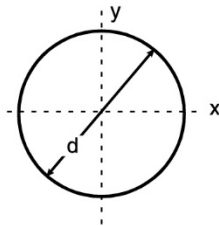

SEGMENT OF A CIRCLE

$$s = 2r \sin \frac{\theta}{2}$$

$$A = \frac{h}{6s} (3h^2 + 4s^2) = \frac{r^2}{2} (\theta - \sin\theta)$$

(θ In Radians)

$$r = \frac{h}{2} + \frac{s^2}{8h}$$

$$h = r(1 - \cos \frac{\theta}{2})$$

$$b = r\theta \frac{\pi}{180} = r \left(\frac{\theta}{57.29} \right)$$

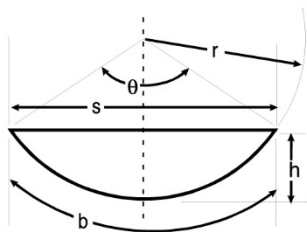
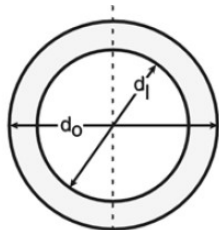

Figure 7-2B. Properties of Plane Surfaces.

HOLLOW RING

$$A = \frac{\pi}{4} (d_o^2 - d_i^2)$$

$$I_x = I_y = \frac{\pi}{64} (d_o^4 - d_i^4)$$



ELLIPSE

$$A = \pi \frac{Dd}{4} = \pi ab$$

$$C \approx \pi \frac{D+d}{2}$$

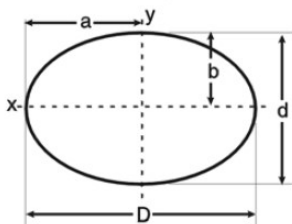

POLYGON

$$A = \frac{ah_1 + bh_2 + bh_3}{2}$$

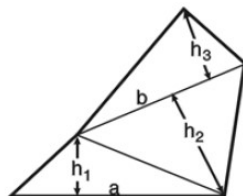

IRREGULAR SURFACES

DIVIDE LENGTH INTO PARALLEL STRIPS OF EQUAL LENGTHS

$$A = b \frac{h_1 + h_2 + h_3 + \dots + h_n}{n}$$

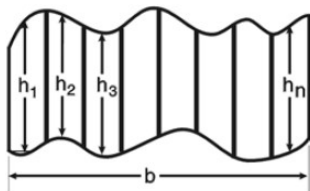

Figure 7-2C. Properties of Plane Surfaces.

CUBE

$$V = a^3$$

$$A_O = 6a^2$$

$$d = a\sqrt{3}$$

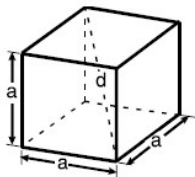

CYLINDER

$$V = \frac{\pi d^2 h}{4}$$

$$\text{Area of sides} = \pi dh$$

$$\text{Total Area} = \pi d \left(h + \frac{d}{2} \right)$$

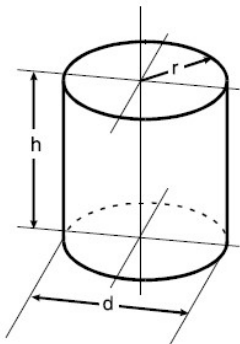

PYRAMID

$$V = \frac{A_1 h}{3}$$

$$A_1 = \text{Area of the base}$$

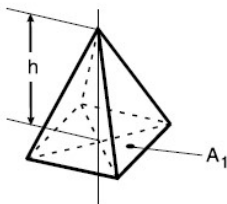

SPHERE

$$V = \frac{\pi d^3}{6}$$

$$V = .524d^3$$

$$A = \pi d^2$$

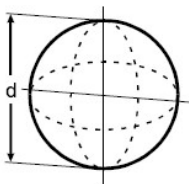
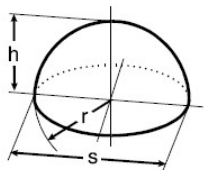

Figure 7-3A. Properties of Solid Bodies.

SPHERE SEGMENT

$$V = \frac{\pi h}{6} \left(\frac{3}{4} s^2 + h^2 \right) = \pi h^2 \left(r - \frac{h}{3} \right)$$

$$A_m = 2\pi r h = \frac{\pi}{4} (s^2 + 4h^2)$$



CUBOID

$$V = abc$$

$$A_o = 2(ab + ac + bc)$$

$$d = \sqrt{a^2 + b^2 + c^2}$$

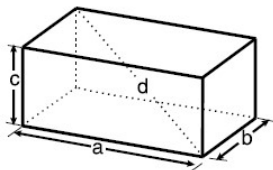

CONE

$$V = \frac{\pi r^2 h}{3}$$

$$A_m = \pi r m$$

$$A_o = A_m + A_1 = \pi r(r + m)$$

$$m = \sqrt{h^2 + r^2}$$

$$A_2 : A_1 = x^2 : h^2$$

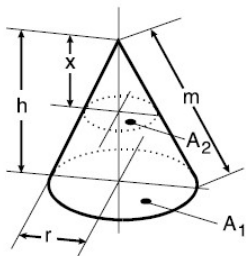

BARREL

$$V = \frac{\pi h}{12} (2D^2 + d^2)$$

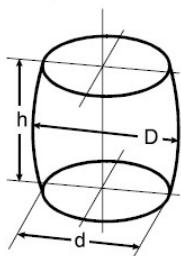

Figure 7-3B. Properties of Solid Bodies.

Table 7-11. Naval Architecture Formulas.

Coefficients of Form	
(a) Block Coefficient	$C_B = \frac{V}{L \times B \times T}$ <p>V = immersed volume, displacement volume</p> <p style="text-align: right;">See 2-2</p>
(b) Midships Coefficient	$C_M = \frac{A_M}{B \times T}$ <p>A_M = immersed area of the midship section</p> <p style="text-align: right;">See 2-2</p>
(c) Waterplane Coefficient	$C_{WP} = \frac{A_{WP}}{L \times B}$ <p>A_{WP} = area of the water plane</p> <p style="text-align: right;">See 2-2</p>
(d) Prismatic Coefficient	$C_P = \frac{V}{A_M \times L}$
Displacement (sea water)	
$\Delta = \frac{C_B \cdot L \cdot B \cdot T}{35} \text{ (saltwater) in Long Tons}$	
$\Delta = \frac{C_B \cdot L \cdot B \cdot T}{36} \text{ (freshwater) in Long Tons}$	
See 2-2	

V = Immersed volume, displacement volume

A_M = Immersed area of the midship section

A_{WP} = Area of the water plane

Table 7-11. Naval Architecture Formulas.

(a) Trim Correction to Mean Draft

$$TC = \frac{d \times t}{L}$$

TC = Correction to mean draft for trim, in inches

d = Distance from the midships section to the center of flotation in feet

t = Trim in inches

L = Length between perpendiculars in feet

(b) Tons Per Inch Immersion (sea water)

$$TPI = \frac{C_{WP} \times L \times B}{420}$$

See 2-2

Simpson's Rule

$$A = \frac{h}{3}(y_0 + 4y_1 + y_2)$$

Height of the Center of Gravity

$$KG = \frac{\Sigma(kg \times w)}{\Sigma w}$$

See 2-4.1.1

(a) Transverse Movement of the Center of Gravity due to weight addition or removal

$$GG_1 = \frac{(Gg)(w)}{W \pm w}$$

See 2-6.1.3

Height of the Center of Buoyancy

$$KB = .55T \text{ (approximate)}$$

$$KB = .5T \text{ (for rectangular barge)}$$

See 2-4.2

Table 7-11. Naval Architecture Formulas.

<p>Transverse Metacentric Radius</p> $BM = \frac{I}{V}$ $I = C_{IT} \times L \times B^3$ <p>Where:</p> <p>C_{IT} = The transverse inertia coefficient and is equal to $C_{WP}^2/11.7$ L = Length between perpendiculars B = Beam</p> <p style="text-align: right;">See 2-4.3.1</p>
<p>Height of the Metacenter</p> $KM = KB + BM$ <p style="text-align: right;">See 2-4.3.2</p>
<p>Metacentric Height</p> $GM = KM - KG$ <p style="text-align: right;">See 2-4.3.3</p>
<p>(a) Righting Arm</p> $GZ = (GM)(\sin\theta)$ <p style="text-align: right;">See 2-4.4</p>
<p>Righting Moment</p> $RM = (W)(GZ)$ <p style="text-align: right;">See 2-4.5</p>
<p>List</p> $\theta = \tan^{-1} \frac{W \times Gg}{W \times GM} \quad (\text{where } W \text{ includes } w)$ <p style="text-align: right;">See 2-6.1.3</p>
<p>Moment to Trim One Inch</p> $MT1 = \frac{(GM_L)(W)}{12L}$ <p style="text-align: right;">See 2-4.6.2</p>

Table 7-11. Naval Architecture Formulas.

(a) Approximate Moment to Trim One Inch

$$MT1 = \frac{(BM_L)(W)}{12L}$$

See 2-4.6.2

Additional Methods to Determine Approximate Moment to Trim One Inch

$$MT1 = \frac{(30)(TPI)^2}{B}$$

$$MT1 = \frac{(L^2)(B)}{10,000}$$

See 2-4.6.2

Trim

$$\delta trim = \frac{\text{trimming moment}}{MT1}$$

(a) Effect of trim on drafts

$$\delta T_f = \frac{\delta \text{ trim(FP to LCF)}}{L}$$

$$\delta T_a = \frac{\delta \text{ trim(AP to LCF)}}{L}$$

(b) Final Draft

$$T_1 = T_0 + \frac{W}{TPI} \pm \delta T$$

 $\frac{W}{TPI}$ accounts for parallel sinkage

Table 7-11. Naval Architecture Formulas.

Free Surface Effect	$GG_1 = \frac{i}{V}$	See 2-5.2
Free Communication Effect	$GG_1 = \frac{(a)(y^2)}{V}$	See 2-5.4
Ground Reaction. There are four primary methods of determining ground reaction. These methods are: change in displacement, TPI, change in draft forward, and change in trim.		
(b) TPI Method	$R = (T_{mbs} - T_{mas})(TPI)$	See 4-2.2
(c) Change in Draft Forward Method	$R = \frac{(TPI)(MT1)(L)(T_{fa} - T_{fs})}{[(MT1)(L) + (TPI)(d_r)(d_r)]}$	See 4-2.4
(d) Change in Trim Method	$R = \frac{MT1(t)}{d_r}$	See 4-2.1

Table 7-11. Naval Architecture Formulas.

<p>Effect of Tides on Ground Reaction</p> $\delta R = \frac{(t)(TPI)(MT1)(L)}{[(TPI)(d^2) + (MT1)(L)]} \quad (\text{If ship can trim})$ $\delta R = (t)(TPI) \quad (\text{If ship not free to trim})$ <p>t = Tide fall</p> <p style="text-align: right;"><i>See 4-2.7</i></p>
<p>Neutral Loading Point</p> $d_n = \frac{(MT1)(L)}{(TPI)(d_r)}$ <p style="text-align: right;"><i>See 4-2.6</i></p>
<p>Freeing Force</p> $F = 1.12\mu R$ <p style="text-align: right;"><i>See 4-3.1</i></p>
<p>Flooding Rates and Hydrostatic Pressure</p>
<p>(a) Flooding Rate</p> $Q = (3,600)(A)(\sqrt{H})$ <p>where:</p> <p>Q = quantity of water in gallons per minute A = area of the hole in square feet H = height of water over the hole in feet</p> <p style="text-align: right;"><i>See 1-4.1</i></p>
<p>(b) Hydrostatic Pressure</p> <p>Pressure at any point on a submerged object:</p> $P(\text{psi}) = .445 \times H \text{ (feet)}$ $P(\text{psf}) = 64 \times H \text{ (feet)}$ <p>where:</p> <p>H = height in feet of seawater over the point where the pressure is desired</p>

Table 7-11. Naval Architecture Formulas.

Hydrostatic Force

$$F = 64Ad$$

where:

F = force in pounds

A = area in square feet

d = average depth of water in feet

If a liquid other than salt water is in the space, its weight per cubic foot should be substituted in the formula in place of 64.

Average force on a bulkhead in an intact space:

$$F = 64A\left(\frac{d}{2}\right)$$

7-3 MATERIAL PROPERTIES

Stability, ground reaction, and pulling force calculations must be as exact as possible. This section lists the densities of liquids and solid materials needed to calculate exactly.

Table 7-12. Material Densities, Volume per Ton, and UW Weight.

SUBSTANCE	AVG DENSITY LB/FT ³	BUOYANCY (seawater) lb/ft ³	DRY VOLUME FT ³ /LTON
METALS AND ORES			
Aluminum, cast-hammered	165	101	13.6
Aluminum alloy	173	109	12.9
Antimony	415	351	5.4
Brass, cast-rolled	534	470	4.2
Bronze, aluminum	481	417	4.7
Bronze, 8 -14% tin	509	445	4.4
Bronze, phosphor	554	490	4.0
Copper, cast-rolled	556	492	4.0
Copper ore, pyrites	262	198	8.5
Gold, cast-hammered	1,205	1,141	1.9
Iron, gray cast	442	378	5.1
Iron, pig	450	386	5.0
Iron, wrought	485	421	4.6
Iron, ferrosilicon	437	373	5.1
Iron ore, hematite	325	261	6.9
Iron ore, limonite	237	173	9.5
Iron ore, magnetite	315	251	7.1
Iron slag	172	108	13.0
Lead	710	646	3.2
Lead ore, galena	465	401	4.8
Magnesium	109	45	20.6
Magnesium alloy	112	48	20.0
Manganese	475	411	4.7
Manganese ore, pyrolusite	259	195	8.6
Mercury	847	783	2.6
Monel, rolled	555	491	4.0
Molybdenum, wrought	643	579	3.5
Nickel	537	473	4.2
Plutonium	1,211	1,147	1.8
Silver, cast-hammered	656	592	3.4
Silver, cast-hammered	656	592	3.4
Tin, cast-hammered	459	395	4.9
Tin ore, cassiterite	418	354	5.4
Titanium alloy	282-302	218-238	7.9-7.4
Tungsten	1,200	1,136	1.9
Uranium	1,184	1,120	1.9
Zinc, cast-rolled	440	376	5.1
Zinc ore, blende	253	189	8.9
OTHER NON-BUOYANT SOLIDS			
Brick			
common	112	48	20.0
fire	150	86	14.9
Chalk	143	79	15.7

Table 7-12. Material Densities, Volume per Ton, and U/W Weight.

SUBSTANCE	AVG DENSITY LB/FT ³	BUOYANCY (seawater) lb/ft ³	DRY VOLUME FT ³ /LTON
OTHER NON-BUOYANT SOLIDS (Continued)			
Concrete,			
cement w/sand, stone	144	80	15.6
cement w/slag	130	66	17.2
cement w/cinder	100	36	22.4
reinforced	150	86	14.9
Cotton, flax, hemp	93	29	24.1
Glass	162	98	13.8
Glass reinforced plastic (GRP)			
linear layup, 30% fiber	117	53	19.1
linear layup, 60% fiber	124	60	18.1
Gypsum, alabaster	159	95	14.1
Limestone	160	96	14.0
Marble	160-177	96-113	14.0-12.7
Pitch	69	5	32.5
Plastics			
Polystyrene	66	2	33.9
Polyvinyl Chloride (PVC)	86	22	26.0
Polycarbonate	75	11	29.9
Nylon	71	7	31.5
Teflon	136	72	16.5
Quartzite	170	106	13.2
Resin, rosin	67	3	33.4
Rubber goods	94	30	23.8
Slate, shale	162-205	98-141	13.8-10.9
Soapstone, talc	169	105	13.3
Sulphur	125	61	17.9
Tar	75	11	29.9
Wool	82	18	27.3
BUOYANT SOLIDS	AVG DENSITY LB/FT ³	U/W WT (SEAWATER) LB/FT ³	DRY VOLUME LB/LTON
Cork	15	49	149
Ice	56	8	40
Leather	59	5	38
Paper	58	6	39
Paraffin	56	8	40
Plastics			
Polyethylene	57-60	4-7	39-37
Polypropylene	56	8	40
Plastic Foams			
Rigid Urethane Foam	1.4-2.0	62-62.6	1,600-1,120
Semi-rigid, MDI Urethane foam	8	56	280
Polystyrene	1.8-3.3	60.7-62.2	1,244-679
PVC, flotation foam (PFD, buoys)	4	60	560
PVC insulation foam	6	58	373
PVC shock-absorbent foam (athletic mats)	7	57	320

Table 7-12. Material Densities, Volume per Ton, and U/W Weight.

SUBSTANCE	AVG DENSITY LB/FT ³	BUOYANCY (seawater) lb/ft ³	DRY VOLUME FT ³ /LTON
BUOYANT SOLIDS (Continued)			
Latex/sponge rubber slabs (furniture padding)	6.5	57.5	345
Syntactic foam	40-47	17-24	56-47
Tallow	58	6	39
Wax	60	4	37
TIMBER			
Ash, white	42	22	53
Cedar, white, red	22	42	102
Chestnut	30	34	75
Cypress	29	35	77
Douglas fir	32	32	70
Eastern fir	25	39	90
Elm	35	29	64
Locust	45	19	50
Mahogany	44	20	51
Maple, sugar	43	21	52
Maple, white	33	31	68
Oak, red, black	42	22	53
Oak, white	48	16	47
Pine, Oregon	32	32	70
Pine, red	30	34	75
Pine, white	27	37	83
Pine, yellow (southern)	40	24	56
Pine, Norway	34	30	66
Poplar	27	37	83
Redwood	26	38	86
Spruce, white, red	28	36	80
Teak, African	62	2	36
Teak, Indian	48	16	47
Walnut	37	27	61
Willow	28	36	80

Table 7-13. Stowage Factors and Cargo Densities.

	STOWAGE FACTOR FT ³ /LTON	STOWAGE FACTOR M ³ /MT	CARGO DENSITY LB/FT ³
BULK ITEMS			
Alumina	33-46	0.92-1.28	49-68
Alumina, calcined	22	0.61	102
Alumina, silica	25	0.70	89
Alumina, silica, pellets	29	0.81	77
Aluminum dross	36	1.00	62
Aluminum nitrate fertilizers	36	1.00	62
Ammonium nitrate fertilizers	34	0.96	65
Ammonium sulphate	36	1.01	62
Antimony ore and residue	14	0.38	164
Asphalt	24-32	0.66-0.91	69-94
Ashes & cinders, packed	53	1.49	42
Barley	57	1.60	39
Barytes	12	0.34	184
Basalt, piled	23	0.65	96
Bauxite (aluminum ore)	28	0.78	80
Borax, anhydrous	28	0.78	80
Borax, pentahydrate (crude, "Rasorite 46")	33	0.92	68
Calcium nitrate fertilizer	33	0.93	67
Carborundum	20	0.56	111
Cement, Portland, loose	24-36	0.67-1.00	62-94
Cement clinkers	22-30	0.61-0.84	74-102
Cereals, barley	57	1.60	39

Table 7-13 (Continued). Stowage Factors and Cargo Densities.

	STOWAGE FACTOR FT ³ /LTON	STOWAGE FACTOR M ³ /MT	CARGO DENSITY LB/FT ³
BULK ITEMS (Continued)			
Cereals, corn, rye	50	1.39	45
Cereals, oats	86	2.40	26
Cereals, wheat	47	1.30	48
Charcoal	160-224	4.46-6.24	10-14
Chamotte (burned clay)	54	1.50	42
Chrome ore	14	0.39	160
Chrome pellets	22	0.60	104
Clay	24-48	0.66-1.34	47-95
Coal, anthracite	39-48	1.08-1.33	47-58
bituminous, lignite	41-56	1.16-1.16	40-54
peat	86-112	2.40-3.12	20-26
Coconuts	140	3.90	16
Coke	45-105	1.25-2.93	21-50
Colemanite	22	0.61	102
Copper granules	9	0.24	260
Copper matte	11	0.30	208
Cryolite	25	0.70	89

Table 7-13 (Continued). Stowage Factors and Cargo Densities.

	STOWAGE FACTOR FT ³ /LTON	STOWAGE FACTOR M ³ /MT	CARGO DENSITY LB/FT ³
BULK ITEMS (Continued)			
Diammonium phosphate	43	1.20	52
Direct reduced iron (DRI)	18	0.50	125
DRI briquettes	13	0.35	178
Dolomite	22	0.60	104
Feldspar lump	22	0.60	104
Ferrochrome	8	0.22	284
Ferromanganese	8	0.23	271
Ferrosilicon	17-26	0.48-0.72	87-130
Fertilizers, non-nitrate	32-50	0.90-1.40	45-69
Fly ash	45	1.26	50
Flourspar (calcium flouride)			
dry	22	0.62	101
wet	18	0.51	122
Granulated slag	32	0.90	69
Gypsum	26	0.73	86
Iron ore	10-29	0.29-0.80	78-215
Iron ore pellets	9-91	0.24-2.53	25-260
Iron ore, taconite pellets	57	1.60	39
Iron oxide, spent	16	0.45	139
Iron sponge, spent	16	0.45	139
Iron pyrites	14	0.40	156

Table 7-13 (Continued). Stowage Factors and Cargo Densities.

	STOWAGE FACTOR FT ³ /LTON	STOWAGE FACTOR M ³ /MT	CARGO DENSITY LB/FT ³
BULK ITEMS (Continued)			
Ironstone	14	0.39	160
Labradorite	22	0.60	104
Lead ore	9-24	0.24-0.67	93-260
Lime, loose	41	1.16	54
Limestone	27	0.75	83
Magnesite	14-30	0.39-0.84	74-160
Manganese ore	11-25	0.32-0.70	89-195
Milorganite	55	1.53	41
Mineral concentrates	12-20	0.33-0.57	110-189
Monammonium phosphate	43	1.21	52
Muriate of Potash	29-40	0.81-1.12	56-77
Peanuts (in shell)	118	3.29	19
Pebbles (rounded, 1-4 in)	21	0.59	106
Pellets, concentrates	17	0.47	133
Perlite (rock)	37	1.02	61
Petroleum coke, pitch prill, prilled coal tar, pencil pitch	45-60	1.25-1.67	37-50
Phosphate, deflourinated	40	1.12	56
Phosphate rock, calcined	23-45	0.64-1.26	50-98
Phosphate rock, uncalcined	25	0.70	89

Table 7-13 (Continued). Stowage Factors and Cargo Densities.

	STOWAGE FACTOR FT ³ /LTON	STOWAGE FACTOR M ³ /MT	CARGO DENSITY LB/FT ³
BULK ITEMS (Continued)			
Pig iron, neatly stowed	11	0.30	208
Portland cement, loose	24	0.67	94
Potash	32	0.90	69
Potassium nitrate (saltpeter)	32	0.88	71
Potassium sulphate	32	0.90	69
Potatoes, piled	51	1.42	44
Pumice	68-117	1.90-3.25	19-33
Pyrite (containing copper and iron)	15	0.41	152
Pyrophyllite	18	0.50	125
Quartz	22	0.60	104
Quartzite	23	0.64	98
Sand, rutile	14	0.39	160
Sand, ilmenite	13	0.36	173
Sand, foundry (quartz)	18	0.50	125
Sand, foundry (silica, feldspar)	35	0.98	64
Sand, zircon	13	0.36	173
Salt	29-40	0.81-1.12	56-77
Salt rock	37	1.02	61
Saltcake (sodium sulphate)	33	0.92	68
Seedcake	50-75	1.39-2.09	30-45

Table 7-13 (Continued). Stowage Factors and Cargo Densities.

	STOWAGE FACTOR FT ³ /LTON	STOWAGE FACTOR M ³ /MT	CARGO DENSITY LB/FT ³
BULK ITEMS (Continued)			
Silica Manganese	8	0.22	284
Soda ash	37-60	1.03-1.67	37-61
Sodium nitrate	32	0.88	71
Stainless steel grinding dust	15	0.42	149
Stone chippings	25	0.71	88
Sugar (raw, brown, white)	36-57	1.00-1.60	39-62
Sulphate of potash and magnesium	34	0.95	66
Sulphur, lump or coarse	27	0.74	84
Superphosphate	33	0.93	67
Superphosphate, triple granular	43	1.20	52
Taconite pellets	57	1.60	39
Talc	25	0.69	90
Urea	42-56	1.17-1.56	40-53
Vermiculite	49	1.37	46
Wheat	47	1.31	48
Wood chips	110	3.07	20
Wood pulp pellets	110	3.07	20
Zircon sand	13	0.36	173

Table 7-13 (Continued). Stowage Factors and Cargo Densities.

	STOWAGE FACTOR FT ³ /LTON	STOWAGE FACTOR M ³ /MT	CARGO DENSITY LB/FT ³
EXCAVATED EARTH, ETC.			
Clay, dry	34	0.95	65
Clay, damp	20	0.56	110
Clay and gravel, dry	22	0.61	100
Clay, stiff or compacted	11-19	0.31-0.52	120-195
Earth, dry, loose	29	0.81	76
Earth, dry, packed	24	0.67	95
Earth, moist, loose	29	0.81	78
Earth, moist, packed	23	0.64	96
Earth, mud, flowing	21	0.58	108
Earth, mud, packed	19	0.53	115
Marble, quarried, loose pile	24	0.67	95
Nitrates, loosely piled	22	0.61	100
Quartz, quarried, loose pile	24	0.67	95
Riprap, limestone	26-28	0.72-0.78	80-85
Riprap, sandstone	25	0.70	90
Riprap, shale	21	0.58	105
Sand, gravel, dry, loose	21-25	0.59-0.70	90-105
Sand, gravel, dry, packed	19-22	0.52-0.61	100-120
Sand, gravel, wet	18	0.50	126

Table 7-13 (Continued). Stowage Factors and Cargo Densities.

	STOWAGE FACTOR FT ³ /LTON	STOWAGE FACTOR M ³ /MT	CARGO DENSITY LB/FT ³
EXCAVATED EARTH, ETC. (Continued)			
Shale, loosely piled	24	0.67	92
Snow, loosely piled	64	1.78	35
Stone, loosely piled	30	0.84	75
PACKAGED ITEMS			
Acid, drums	45	1.25	50
Apples, boxes	80	2.23	28
Autos, disassembled, crated	110	3.07	20
Autos, assembled	270	7.53	8
Auto parts, cases	90	2.51	25
Barbed wire, rolls	55	1.53	41
Beans, bags	60	1.67	37
Beer, bottles in cases	80	2.23	28
Biscuits, cases	142	3.96	16
Blankets, bales	153	4.27	15
Burlap, bales	52	1.45	43
Butter, cases	60	1.67	37
Canned goods, cases	38-50	1.06-1.39	47-59
Cable, reels	31	0.86	72
Cardboard, bundles	210	5.85	11
Carpets/rugs	75	2.08	30
Carpets/rugs, bales	140	3.90	16
Cartridges, boxes	30	0.84	75

Table 7-13 (Continued). Stowage Factors and Cargo Densities.

	STOWAGE FACTOR FT ³ /LTON	STOWAGE FACTOR M ³ /MT	CARGO DENSITY LB/FT ³
PACKAGED ITEMS (Continued)			
Castings, boxes	22	0.61	102
Cement, bags	35	0.98	64
Cheese, boxes	45	1.25	50
Coffee, bags	58	1.62	39
Conduits, boxes	31	0.86	72
Copper, slabs	7	0.20	320
Copper, bars	10	0.28	224
Cork, bales	187	5.21	12
Corn, bags	55	1.53	41
Cotton, bales	90	2.50	25
Dried fruit, boxes	45	1.25	50
Dry goods, boxes	100	2.79	22
Earth, bags	56	1.56	40
Eggs, cases	100	2.79	22
Electric motors, boxes	50	1.39	45
Engines, gasoline, cases	100	2.79	22
Excelsior, bales, compressed	118	3.29	19
Fish, barrels, iced	50	1.39	45
Fish, boxes	65	1.81	34
Flour, bags	48	1.34	47
Flour, barrels	73	2.04	31

Table 7-13 (Continued). Stowage Factors and Cargo Densities.

	STOWAGE FACTOR FT ³ /LTON	STOWAGE FACTOR M ³ /MT	CARGO DENSITY LB/FT ³
PACKAGED ITEMS (Continued)			
Fruit juice, bottles in case	70	1.95	32
Furniture, crated	156	4.35	14
Gasoline, drums	61	1.70	37
Glass, crated	130	3.62	17
Grapefruit, boxes	70	1.95	32
Hardware, boxes	50	1.39	45
Hay, bales	112	3.12	20
Hemp, bales, compressed	97	2.72	23
Hides, raw, bales	102	2.84	22
Hides, bales, compressed	80	2.23	28
Iron pigs, neatly stowed	10	0.28	207
Jute, bales, compressed	55	1.52	41
Lanterns, cases	375	10.45	6
Lard, boxes	45	1.25	50
Laths, bundles	107	2.98	21
Lead pigs, neatly stowed	8	0.22	280
Leather, bales	80	2.23	28
Lime, bags	52	1.45	43
Linen, cotton goods, boxes	45-64	1.25-1.78	35-50

Table 7-13 (Continued). Stowage Factors and Cargo Densities.

	STOWAGE FACTOR FT ³ /LTON	STOWAGE FACTOR M ³ /MT	CARGO DENSITY LB/FT ³
PACKAGED ITEMS (Continued)			
Linoleum, rolls	70	1.95	32
Linseed, bags	60	1.67	37
Machinery, crated	46-50	1.28-1.39	45-49
Magazines, bundles	75	2.09	30
Mail, 55 lb bags	180	5.02	12
Meat, cold storage	95	2.65	24
Molasses, barrels	47	1.30	48
Newspapers, bales	120	3.35	19
Nitrate, bags	26	0.72	86
Nuts, bags	70	1.95	32
Oats, bags	77	2.15	29
Oil, drums	45	1.25	50
Oil, cases	50	1.39	45
Onions, bags	78	2.17	29
Oranges, boxes	78	2.17	29
Oysters, barrels	60	1.67	37
Paint, cans	36	1.00	62
Paint drums	24	0.67	93
Paper, rolls	80	2.23	28
Paper, bales	80	2.23	28
Paper, boxes	60	1.67	37
Peas, bags	55	1.53	41

Table 7-13 (Continued). Stowage Factors and Cargo Densities.

	STOWAGE FACTOR FT ³ /LTON	STOWAGE FACTOR M ³ /MT	CARGO DENSITY LB/FT ³
PACKAGED ITEMS (Continued)			
Potatoes, bags	60	1.67	37
Poultry, boxes	95	2.65	24
Plumbing fixtures, crates	100	2.79	22
R.R. rails, neatly stowed	15	0.42	149
Rags, bales	118	3.29	19
Raisins, boxes	54	1.51	41
Rice, bags	58	1.62	39
Roofing paper, rolls	80	2.23	28
Rope, coils	72-90	2.01-2.51	25-31
Rubber, bundles	140	3.90	16
Rum, casks	60	1.67	37
Salt, barrels	52	1.45	43
Silk, bales	110	3.07	20
Silk, bolts	80	2.23	28
Soap, boxes	45	1.25	50
Soap powder, boxes	90	2.51	25
Starch, boxes	59	1.64	38
Steel bolts, kegs	21	0.59	107
Steel rods, neatly stowed	12	0.33	187
Steel sheets, crated	36	1.00	62
Straw, bales	118	3.29	19

Table 7-13 (Continued). Stowage Factors and Cargo Densities.

	STOWAGE FACTOR FT ³ /LTON	STOWAGE FACTOR M ³ /MT	CARGO DENSITY LB/FT ³
PACKAGED ITEMS (Continued)			
Sugar, bags	47	1.31	48
Tallow, barrels	66	1.84	34
Tar, barrels	54	1.51	41
Tea, cases	95	2.65	22
Thread, cases	60	1.67	37
Tile, boxes	50	1.39	45
Timber, oak	39	1.09	57
Timber, fir	65	1.81	34
Tin, sheets	7	0.20	320
Tires, bundles	168	4.68	13
Tobacco, boxes	134	3.74	17
Transformers, cases	30	0.84	75
Typewriters, cases	110	3.07	20
Waste, cotton, bales	175	4.88	13
Wax, vegetable, bags	50	1.39	45
Wax, barrels	70	1.95	32
Wheat, bags	52	1.45	43
Wool, bales, compressed	160	4.46	48
Zinc, slabs	7	0.20	320

Table 7-14. Liquid Densities.

	Density lb/ft ³	Density lb/gal	Volume ft ³ /ton	Volume gal/ton
Alcohol, ethyl (100%)	49	6.6	45.7	342
Alcohol, methyl (100%)	50	6.7	44.8	335
Acid, muriatic (40%)	75	10.0	29.9	223
Acid, nitric (91%)	94	12.6	23.8	178
Acid, sulphuric (87%)	112	15.0	20.0	150
Acid, hydrochloric (37%)	75	10.0	29.9	224
Battery electrolyte				
fully charged	81	10.8	27.6	207
discharged	69	9.2	32.6	244
Beer	63	8.4	35.5	266
Ammonia @ 32°F	39	5.2	57.6	431
Chloroform	95	12.7	23.6	176
Diesel fuel (DFM, NATO F-76)	52	7.0	42.7	320
Ether	46	6.2	48.7	364
Ethylene Glycol (anti-freeze)	70	9.4	31.9	239
Fuel oil, No 6	60	8.1	37.1	278
Fuel oil, No 5	58	7.8	38.4	287
Fuel oil, No 2	55	7.3	40.9	306
Fuel oil, No 1	51	6.8	44.3	332
Gasoline	44	5.9	50.6	379
Jet fuel (JP5)	51	6.9	43.5	326

Table 7-14. Liquid Densities.

	Density lb/ft ³	Density lb/gal	Volume ft ³ /ton	Volume gal/ton
Kerosene	50	6.7	44.9	336
Milk	64	8.6	34.8	260
Linseed oil	59	7.8	38.3	286
Lye, soda (66%)	106	14.2	21.1	158
Oil, vegetable	58	7.8	38.3	289
Oil, lubricating	56	7.5	21.1	298
Olive oil	57	7.6	38.6	293
Petroleum, crude	44	5.8	39.9	383
Sugar-in-water solution				
20% @ 68°F	67	9.0	33.2	248
40% @ 68°F	73	9.8	30.5	228
60% @ 68°F	80	10.7	27.9	209
Turpentine	54	7.2	41.5	310
Vinegar	67	9.0	33.2	249
Water, pure, @ 39°F	62	8.3	35.9	269
Water, seawater	64	8.6	35.0	262
Water, ice	56	7.5	40.0	299
<p>Note: Liquids consisting of a mixture of compounds, such as petroleum products and vegetable derivatives, may vary in density from sample to sample. The densities given in this table are average or typical values. Liquid densities, especially those of petroleum products, can also vary significantly with temperature. The values given in this table should be used for rough approximations only. If more precise calculations are necessary, values for density should be obtained from ship's documents or personnel, or by testing.</p>				

7-4 SALVAGE MACHINERY AND EQUIPMENT

Ref: *ESSM CAT*

This section lists salvage machinery characteristics, shipping dimensions, capacities and operating parameters.

Table 7-15. Salvage Machinery Characteristics.

Equipment	L	W	HT	CU FT ³	WT	CAT#
COMPRESSORS						
175 CFM (100 PSI)	88	45	56	129	2,632	AC0330
Ancillary Set	56	37	23	28	450	AC0331
Spare Parts	28	27	19	8	44	AC0332
600 CFM (100 PSI)	175	77	92	715	6,680	AC0301
600 CFM (100 PSI)	200	96	93	1,033	14,420	AC0317
Ancillary Set	-	-	-	-	-	-
Spare Parts	-	-	-	-	-	-
GENERATORS						
5KW 120/240 VAC 1-PH	36	22	36	17	680	GE0401
Spare Parts	21	16	12	2.5	18	GE0402
5KW 120/240 VAC 1-PH/3-PH	52	32	39	38	1,020	GE0404
Spare Parts	21	16	12	2.5	14	GE0405
30KW 220/440 VAC 3PH	87	39	59	114	3,700	GE0410
Spare Parts	36	28	14	8	56	GE0411
30KW 120/240/416 VAC 3PH	80	36	55	92	2,865	GE0450
Spare Parts	-	-	-	-	-	GE0451
30KW 120/208/240/480 VAC 1PH/3PH	90	45	54	127	3,854	GE0460
Spare Parts	-	-	-	-	-	GE0461
SKW Light Tower	77	56	57	142	2,100	LT00430
Spare Parts	18	12	9	2.5	10	LT0431
120V Light System	81	45	42	89	1,045	LT0440
PUMPS						
3-inch 350 GPM, Diesel	36	26	36	20	680	PU0201
Set, Ancillary	143	23	22	42	758	PU0203
Kit, Spare Parts	18	12	12	1.5	68	PU0202
3-inch, Trash, Diesel	-	-	-	-	-	PU0234
Set, Ancillary	62	36	42	-	890	PU0235
6-inch 500 GPM, Diesel	65	30	48	54	2,360	PU0210
Set Ancillary	91	31	30	81	1,260	PU0212
Kit, Spare Parts	28	18	15	4.5	52	PU0211
10-inch, 3,000 GPM Diesel	83	33	52	83	3,200	PU0220
Set Ancillary	91	31	30	81	-	PU0224
Kit, Spare Parts	36	28	14	8.5	68	PU0224
4-inch Submersible, Hydraulic	-	22	19	4.5	95	PU0208
Power Unit	96	34	58	110	3,840	PW0045
Kit, Spare Parts	21	16	12	2.5	28	PW0046

Table 7-15. Salvage Machinery Characteristics.

Equipment	L	W	HT	CU FT ³	WT	CAT#
PUMPS (CONT)						
Reel, Hydraulic Hose	47	32	49	42	730	HC0003
6-inch, Submersible, Hydraulic	12	12	-	2.5	200	PU0290
Set, Ancillary	62	36	39	53	1,560	PU0291
Block, Hydraulic Flow Control	32	29	28	15	240	PU0292
Power Unit	96	34	58	110	3,840	PW0045
Kit, Spare Parts	21	16	12	2.5	28	PW0046
Reel, Hydraulic Hose	47	32	49	42	730	HC0003
4-inch, Submersible, Electric	72	29	53	64	1,560	PU0240 (Water, Fuel Oil, Light Off)
Kit, Spare Parts	-	-	-	-	-	PU0241
2 1/2-inch, Jetting 300 psi	120	50	65	226	4,295	PU0229
2 1/2-inch, Jetting 250 psi	110	38	77	187	4,450	PU0330
Set, Ancillary	91	31	30	81	1,260	PU0232
Kit, Spares (PU0230)	36	28	14	8.5	60	PU0231
MISCELLANEOUS						
Puller System, Hydraulic Cable	-	-	-	-	-	S17100
Cable Puller, 50-Ton	123	41	21	62	5,500	HC0012
Set, Ancillary	62	37	42	46	2,703	HC0015
Kit, Spare Parts	36	26	14	10	215	HC0013
Reel Assembly, Hose	47	32	49	42	730	HC0013
Bridle Assembly	80	40	10	21	610	HC0047
Control Panel	40	26	26	16	385	HC0049
Power Unit	96	34	58	110	3,840	PW0045
Kit, Spare Parts	21	16	12	2.5	28	PW0046
Pontoon, 8.4 Ton	72	48	33	66	1,236	PN0049 (unmodified)
Pontoon, 8.4 Ton	72	48	33	66	1,236	PN0050 (modified)
Deflation Device	43	20	23	4	34	PN0051
Kit, Pontoon Mod.	9	9	4	1	12	PN0052
Tension Meter	-	-	-	-	-	S24100
Loadcell, 50-Ton	26	16	14	3	264	TE0051
Gauge, 50-Ton	32	32	24	6	104	TE0051
Kit, Spare Parts	11	4	7	1	5	TE0053
400 AMP Welder	82	32	59	90	3,250	WL0470
Kit, Spare Parts	36	26	13	7	14	WL0471
Winch, 8-Ton, Diesel	98	60	61	208	7,060	WN0010
Kit, Spare Parts	17	12	9	1	14	WN0011

7-4.1.1 Pump Performance

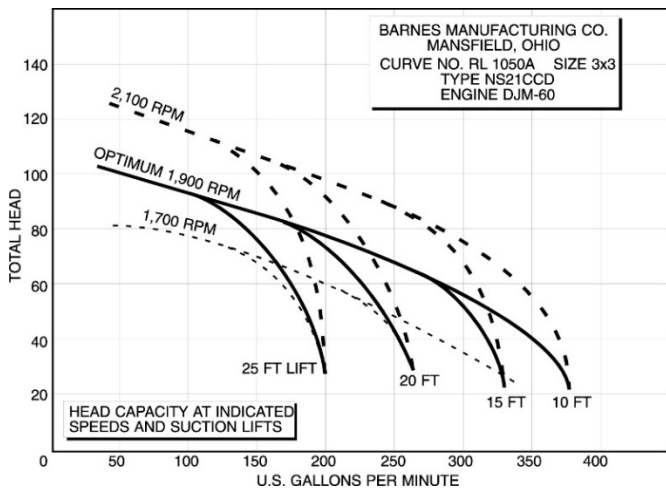

Figure 7-4A. Performance Curve, 3" Diesel Pump.

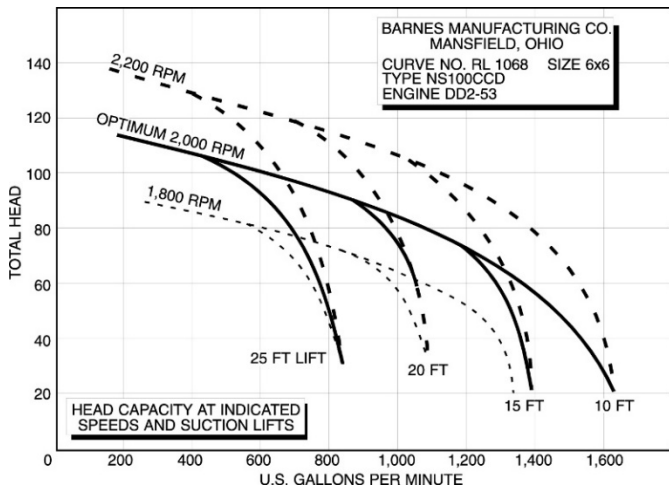

Figure 7-4B. Performance Curve, 6-inch Diesel Pump.

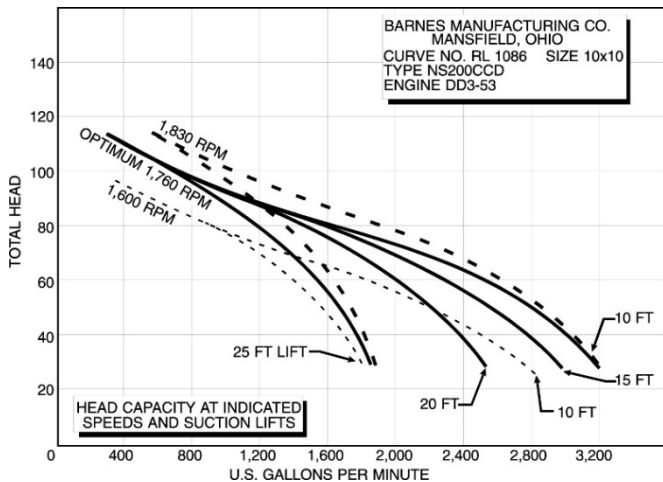

Figure 7-4C. Performance Curve, 10" Diesel Pump.

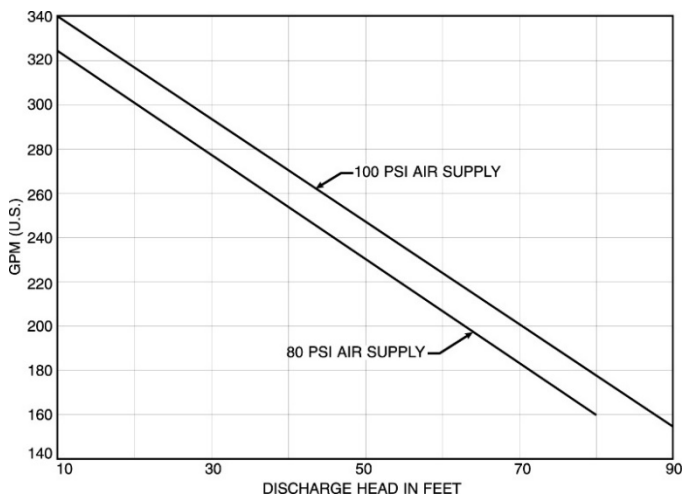

Figure 7-4D. Performance Curve, 2 1/2" Air Submersible Pump.

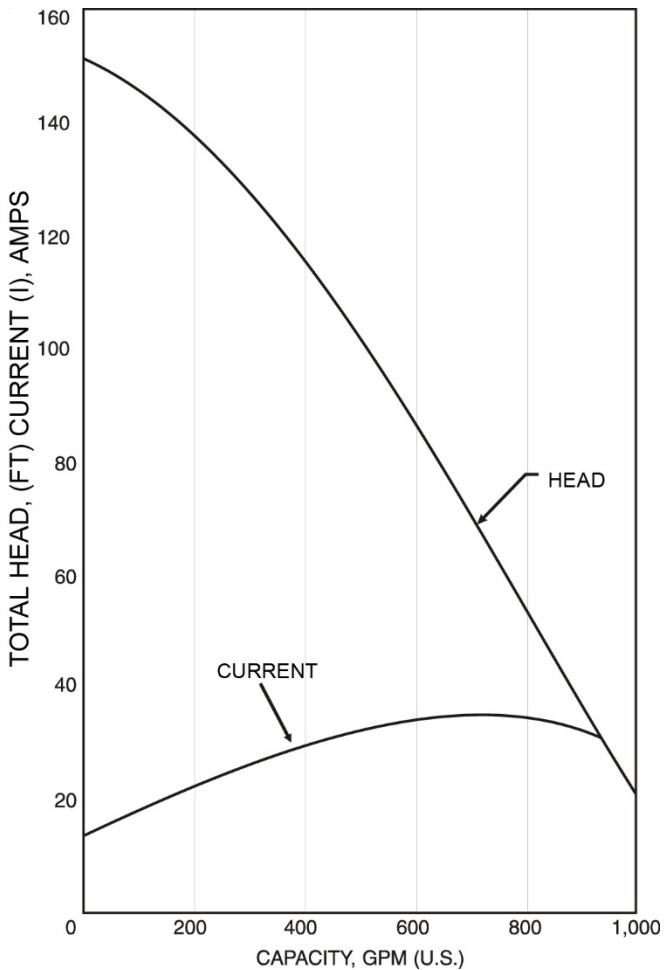

Figure 7-4E. Performance Curve, U.S. Navy 4" Electric Submersible Pump (Impeller No. 1).

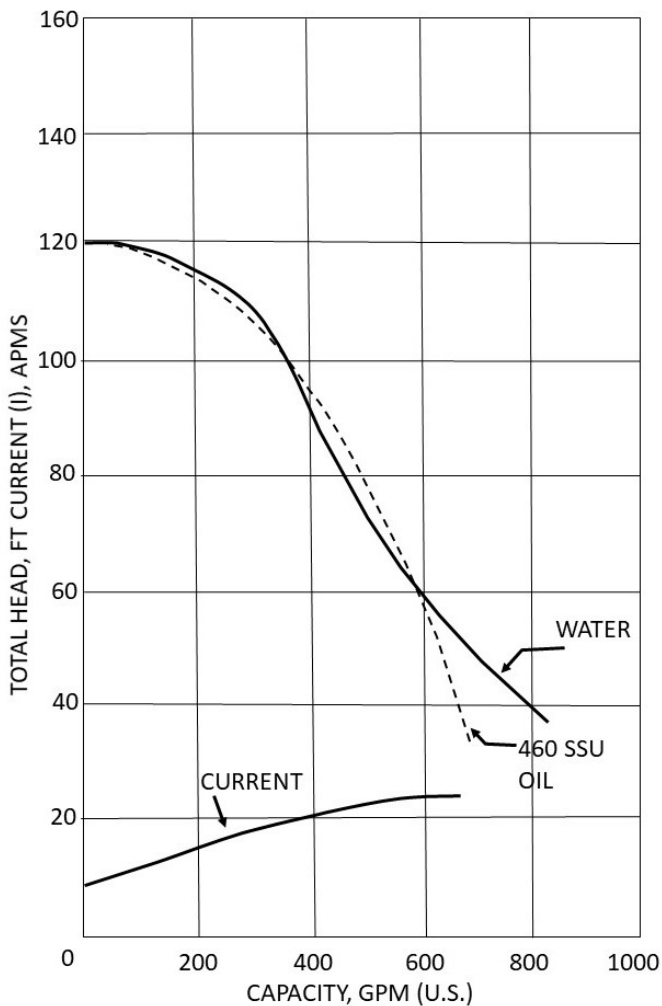

Figure 7-4F. Performance Curve, U.S. Navy 4" Electric Submersible Pump (Impeller No. 2).

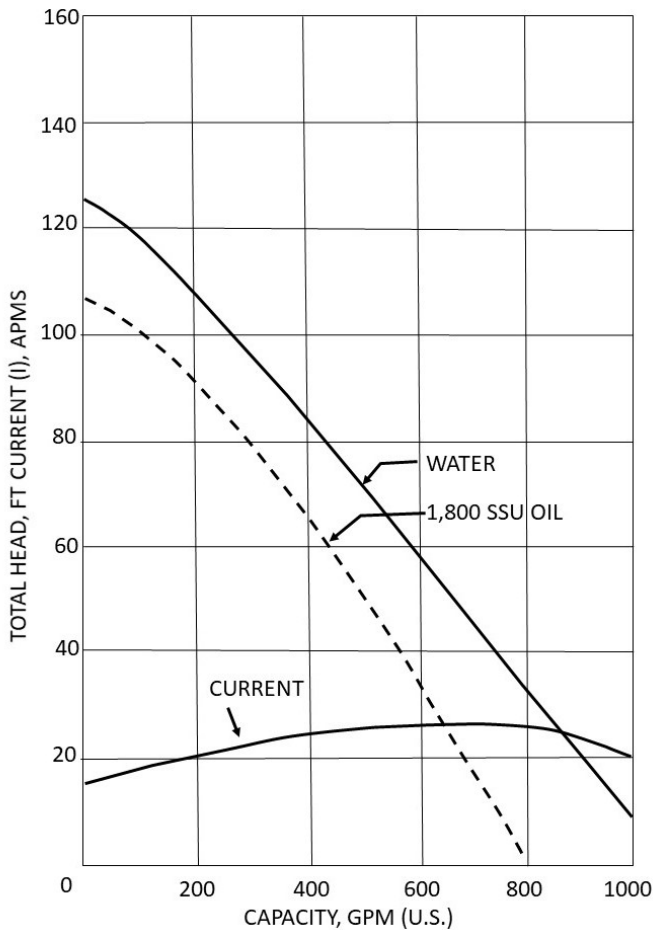

Figure 7-4G. Performance Curve, U.S. Navy 4" Electric Submersible Pump (Impeller No. 4).

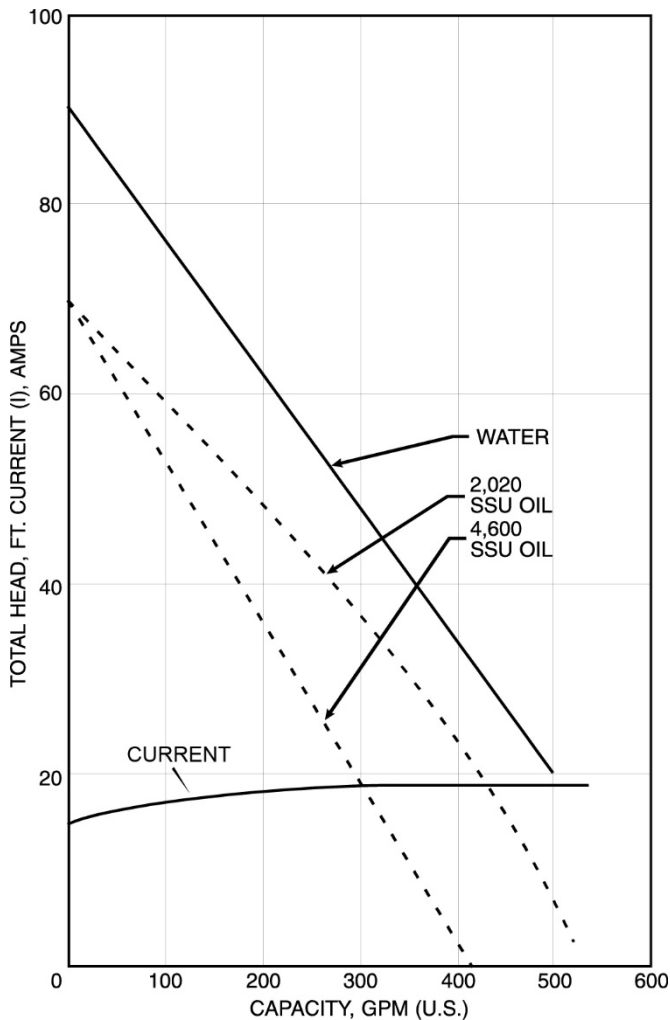

Figure 7-4H. Performance Curve, U.S. Navy 4" Electric Submersible Pump (Impeller No. 3).

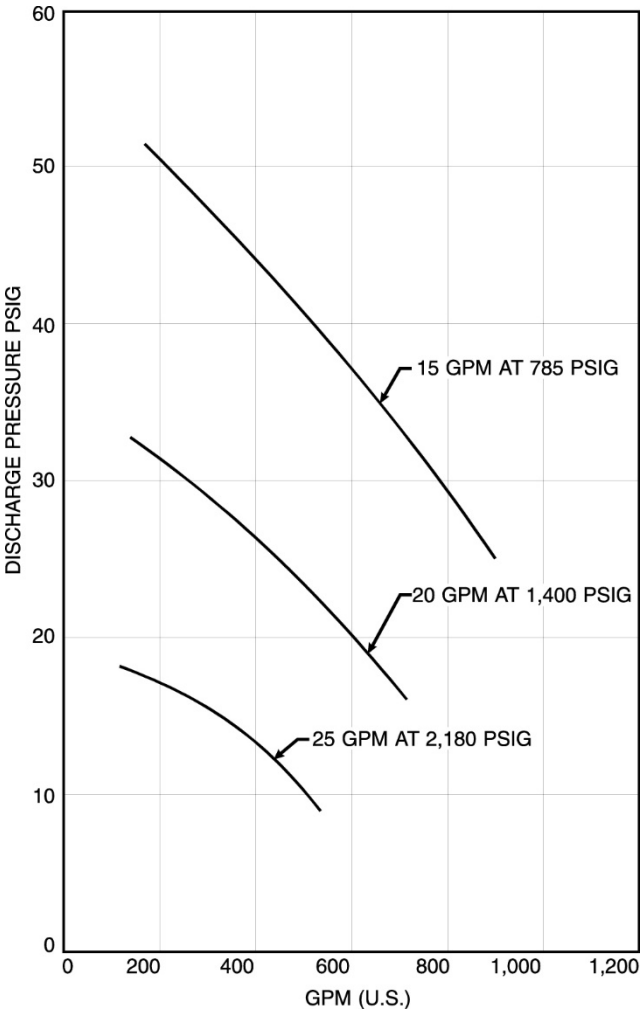

Figure 7-4I. Performance Curve, 4" Hydraulic Submersible Pump.

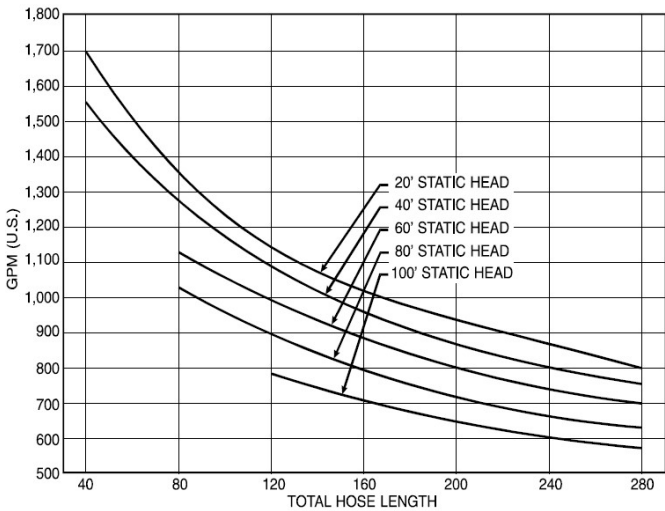

Figure 7-4J. Performance Curve (Water), CCN-150 Pump (4" Hose).

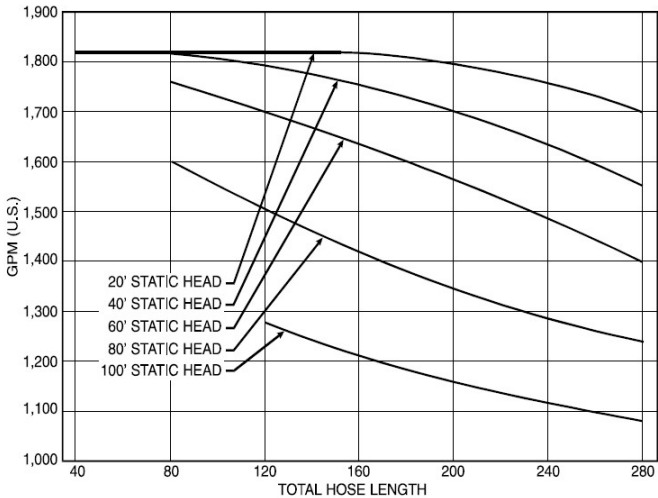

Figure 7-4K. Performance Curve, CCN-150 (Water), CCN-150 Pump (6" Hose).

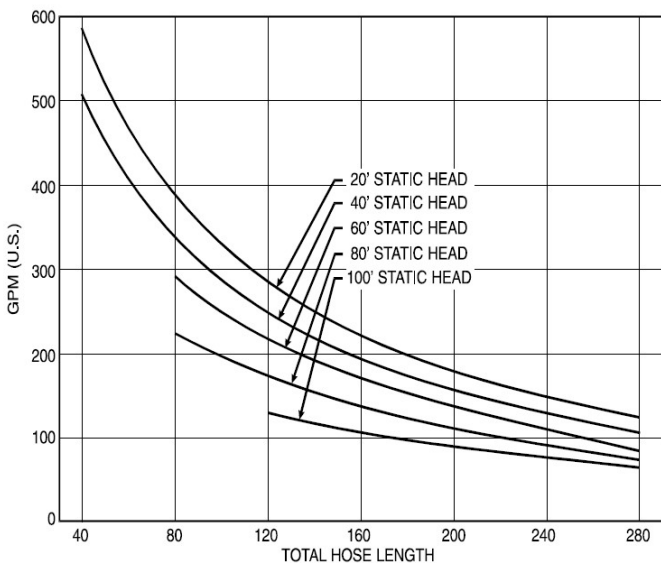

Figure 7-4L. Performance Curve, (Warm #6) CCN-150 Pump (4" Hose).

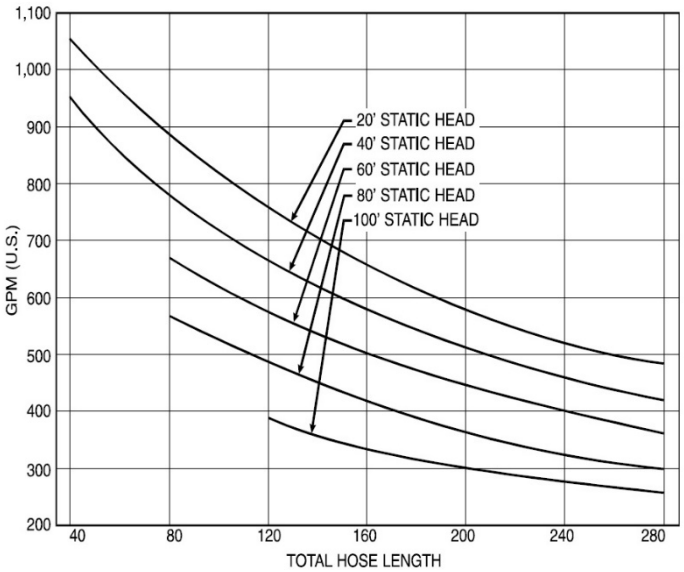

Figure 7-4M. Performance Curve, (Warm #6) CCN-150 Pump (6" Hose).

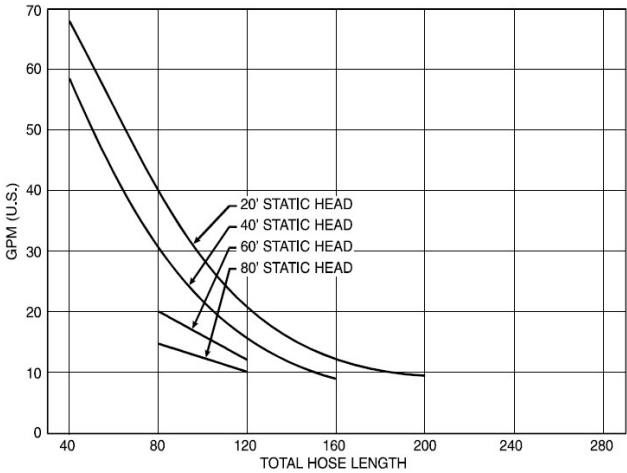

Figure 7-4N. Performance Curve, (Cold #6) CCN-150 Pump (4"

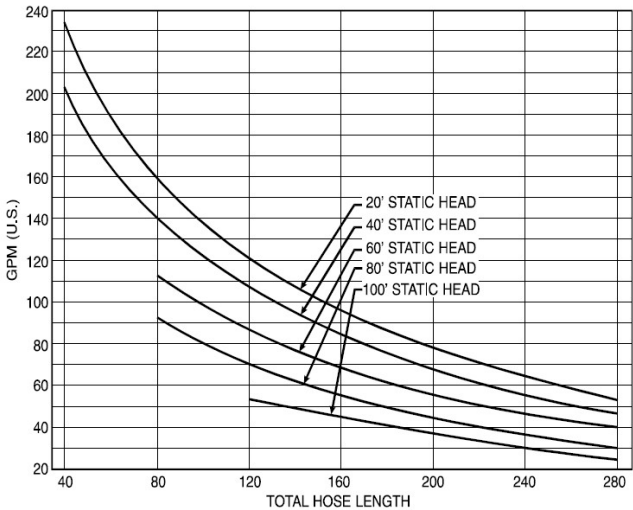

Figure 7-4O. Performance Curve, (Cold #6) CCN-150 Pump (6" Hose).

APPROXIMATE DIESEL ENGINE POWER REQUIRED.

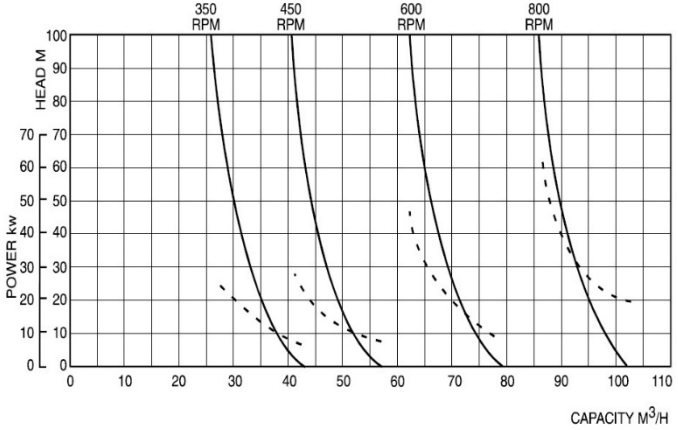

Figure 7-4P. Performance Curve, (Water) DOP-250 Pump.

7-5 HELICOPTERS

Refs: *SAL ENG; Jane's Aircraft and Polmar's Ships and Aircraft*

Helicopters provide the fastest method for transferring salvage machinery and equipment to casualties. Military helicopters may be the only flying assets available during remote salvage operations. This section lists the range and load capacity of several U.S. military helicopters.

Table 7-16. Helicopter Characteristics and Payload.

Type/Name	Crew	Weight (Tons) Empty/Full	Dimension (Feet) LOA/Rotor	Range (NM)	Speed (kts)	Payload (lbs)	Cabin Dimension (feet)
H-46 USN Sea Knight	3	6.5/11.5	84/51	100	140	4,200 Internal	30 x 7.5x 8.3
CH-47 USA Chinook	3	11.5/27	99/72	30/100	161	23,049 External	30 x 7.5x 8.3
Commercial Chinook	3	13.5/26	99/72	610	135	20,000 28,000 External	30 x 7.5x 8.3
CH-46E USMC Sea Knight	3	11.5/25	99/60	30/100	152	23,049 External	30 x 7.5x 8.3
CH-53D USMC Sea Stallion (1)	3	11.5/21	88/72	540	173	8,000 + 4,000 Overload	30 x 7.5x 8.3
RH-53D USN Sea Stallion (2)	7	11.5/21	88/72	540	173	8,000 + 4,000 Overload	30 x 7.5x 8.3
CH-53E USA Super Stallion	3	16-18/37	99/79	1,120	150	30,000 36,000 External	30 x 7.5x 6.5
CH-53D USMC (Modified)	3	16-18/37	99/79	1,120	150	32,000 36,000 External	30 x 7.5x 6.5
MH-53E USN Sea Dragon	4	16-18/37	99/79	1,120	150	30,000 36,000 External	30 x 7.5x 6.5
SH-3/SH-3H USN Sea King (3)	4	6/10	72/62	625	136	Limited	30 x 7.5x 6.5
HH-3 USAF Jolly Green Giant (4)	4	6/10	72/62	625	136	Limited	30 x 7.5x 6.5
CH-3C/E USAF Sea Train (5)	4	6/10	72/62	625	136	Limited	30 x 7.5x 6.5
HH-3F USCG Pelican (6)	4	6/10	72/62	625	136	Limited	30 x 7.5x 6.5
SH-60B/R	3	7.1/10.8	65/53	450	145	4100	N/A
SH-60F	3	7.1/5.6	65/53	600	145	4100	N/A
UH/HH 1N/Y	3/4	3/5.6	57/48	280	102	5000	7 FT 8IN X 8FT
AH-1W/Z	2	5/7.4	58/48	317	150	N/A	N/A
AH-64A/D	2	6/11	51/48	260	182	N/A	N/A

NOTE: (1) Assault (2) MCM (3) ASW (4) Rescue (5) Cargo (6) SAR Commercial

7-6 MISCELLANEOUS INFORMATION

7-6.1 Wind Force. The force per square foot experienced when wind is blowing perpendicular to a surface is calculated by:

$$F = 0.004V^2S$$

where:

F = force of the wind in pounds

V = wind velocity in knots

S = surface area

7-7.2 Current Force. The force exerted by a current on ship hulls and similar shapes can be determined from the following empirical relationship: (Salvage Engineers Handbook, 3-4.5.1)

$$F_c = \rho Au^2 C_d K$$

where:

F_c = current force, pounds

ρ = water mass density, slugs/ft³ = $\gamma g_c/g$

γ = weight density lbf/ft³

g = acceleration of gravity x 32.174 ft/sec²

g_c = gravitational acceleration constant = 1 slug-ft/
lbf-sec²

A = projected underwater area \approx length x draft

u = current velocity, ft/sec

C_d = drag coefficient (Figure 7-4Q)

K = depth correction factor (Figure 7-4R)

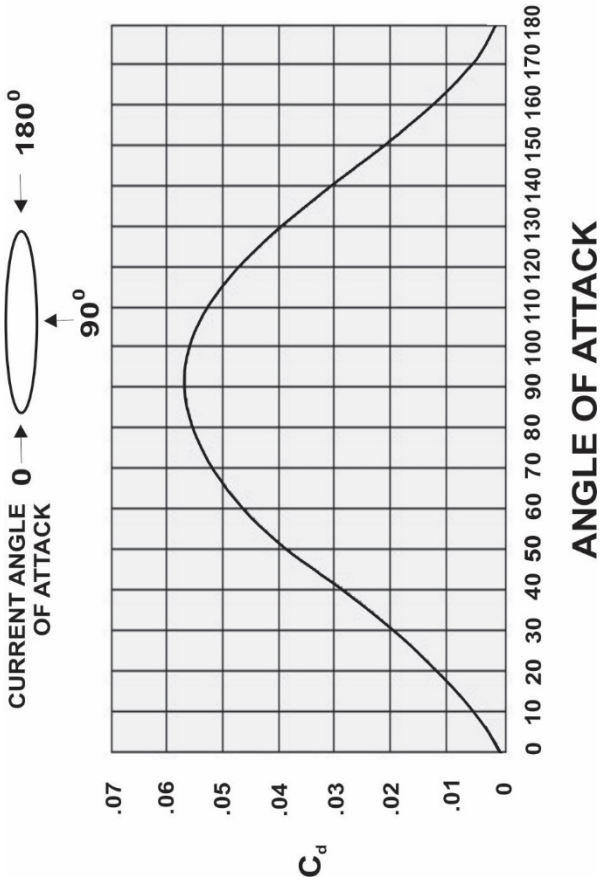

Figure 7-4Q. Current Drag Coefficient (C_d)

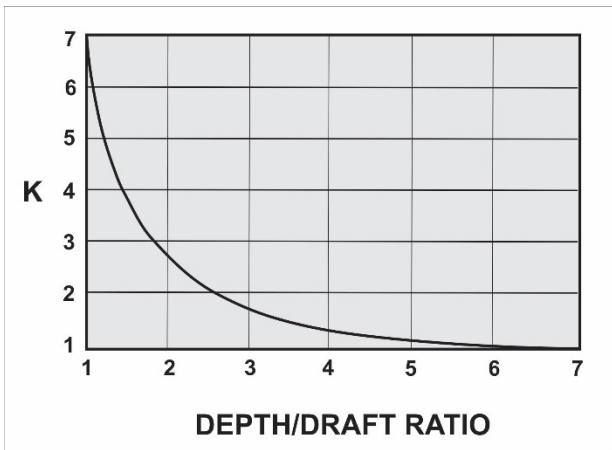

Figure 7-4R. Current Force Depth Correction Factor (K)

7-6.1.1 7-7.3 Catenary Calculations.

$$C = T/W - T/W \sqrt{1 - (WS/2T)^2}$$

C = Catenary or sag (ft)

T = Steady Tension (lbs force)

W = Weight of towline in water per unit length (lbs/ft)

S = Total scope (ft) (total of all components)

Steady tension (T) may be estimated by using the tension meter on the towing machine, by using the chart of Available Tension vs. Ship's Speed for U.S. Navy Towing Ships, or by the estimating procedure in Appendix G of the Towing Manual.

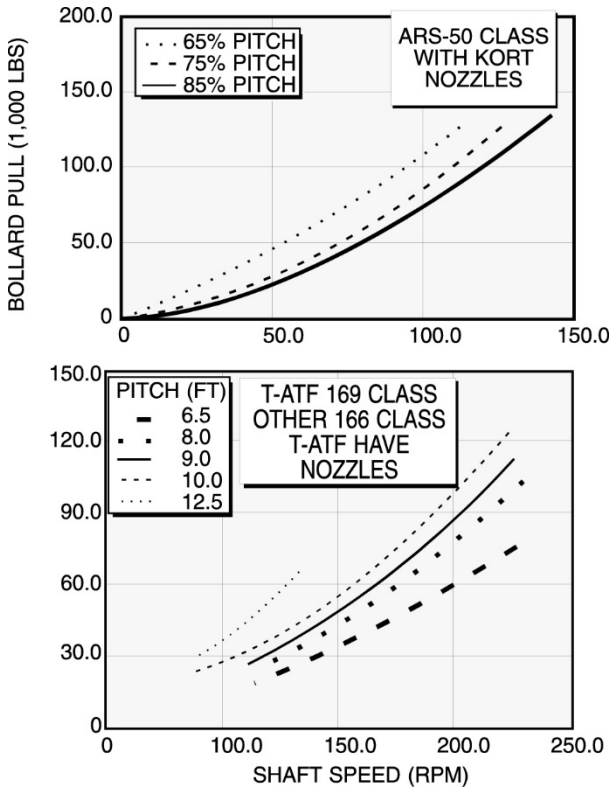
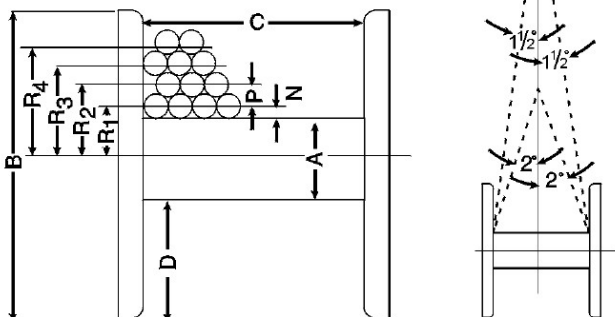

Figure 7-5. Bollard Pull Curves

**MAX. FLEET ANGLE
FOR PROPER WIRE
ROPE SPOOLING**



DRUM DIMENSIONS ARE TO BE MEASURED IN INCHES

ROPE DIA	1/8	3/16	1/4	5/16	3/8	7/16	1/2	9/16	5/8
FACTOR K	13.2	0.14	3.29	2.21	1.58	1.19	.925	.741	.607
DIM. N	.063	0.94	.125	.156	.188	.219	.250	.281	.313
DIM. P	.108	.162	.217	.271	.325	.379	.433	.488	.541

ROPE DIA	3/4	7/8	1	1 1/8	1 1/4	1 3/8	1 1/2	1 5/8	1 3/4
FACTOR K	.428	.308	.239	.191	.152	.127	.107	.088	.077
DIM. N	.375	.483	.500	.563	.625	.688	.750	.813	.875
DIM. P	.650	.758	.866	.974	1.083	1.191	1.299	1.407	1.516

ROPE DIA	1 7/8	2
FACTOR K	.067	.060
DIM. N	.938	1.000
DIM. P	1.624	1.732

PITCH RADIUS (R₁, R₂, ETC.) INCHES

$$R = \frac{A}{2} + N + P(\text{NUMBER OF WRAPS} - 1)$$

LINEPULL (LP) POUNDS

$$LP = \frac{\text{DRUM TORQUE (T)}}{R}$$

LINE SPEED (LS) FPM

$$LS = \frac{2R \times 3.14 \times \text{DRUM RPM}}{12}$$

CABLE STORAGE CAPACITY FT.

$$\text{LENGTH OF ROPE} = (D + A) \times D \times C \times \text{FACTOR K}$$

PITCH DIAMETER OF WRAPS (PD)

$$PD = 2R$$

DRUM RPM

$$\text{RPM} = \frac{\text{LINE SPEED} \times 12}{2R \times 3.14}$$

DRUM DIAMETER INCHES

$$A = \frac{(\text{LINE SPEED} \times 12)}{\text{DRUM RPM} \times 3.14} - \text{ROPE DIAMETER}$$

DRUM DIAMETER INCHES

$$A = \left(\frac{2 \text{ DRUM TORQUE}}{\text{LINE PULL}} \right) - \text{ROPE DIAMETER}$$

DRUM TORQUE (T) IN POUNDS

$$T = \text{LINEPULL} \times R$$

Figure 7-6. Drum Barrel Calculations.

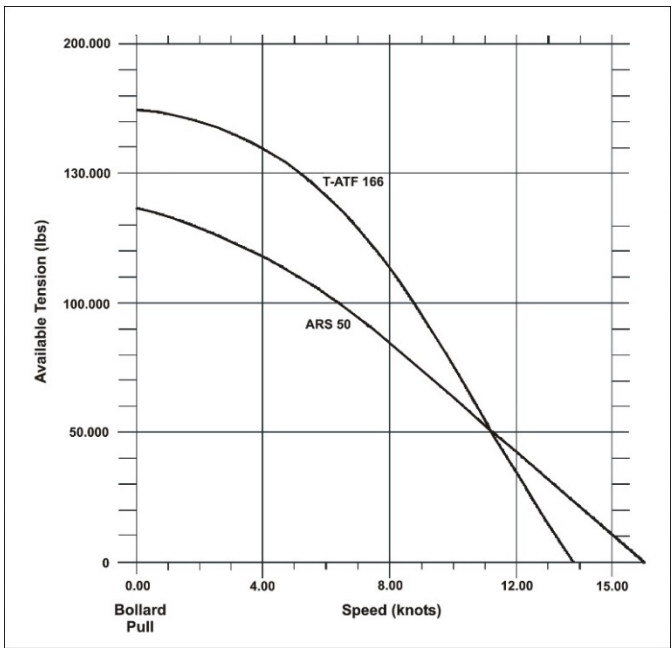

Figure 7-7. Available Tension vs. Ship's Speed for U.S. Navy Towing Ships.

Table 7-17. Cold Weather Operation.

Recommended Operational Limits of ESSM Equipment		
Equipment	Nominal Operational Limit	Operational Limit with Winterizing
8-ton diesel winch	-10 °F	-60 °F
3-inch diesel pump	-10 °F	-60 °F
6-inch diesel pump	-10 °F	-60 °F
10-inch diesel pump	-10 °F	-60 °F
4-inch electric submersible pump	-10 °F	-60 °F
4-CFM HP gasoline air compressor	-10 °F	N/A
125-CFM HP diesel air compressor	-10 °F	-60 °F
5-KW diesel generator	-10 °F	-60 °F
30-KW diesel generator	-10 °F	-60 °F
5-KW diesel light tower	-10 °F	-60 °F
400-amp diesel welder	-10 °F	-60 °F
Beach gear	0 °F	-60 °F
Inflatable 8.5-ton pontoon	32 °F	-60 °F
Polyurethane foam	32 °F	32 °F
Recommended Hydraulic Starting System Pressures		
Temperature	Pressure	
Above 40 °F	1,500 psi	
0 °F to 40 °F	2,500 psi	
Below 0 °F	3,300 psi	
Diesel Fuels Suitable for Extreme Cold Weather		
Specification Number	Grade	
VV-F-800D	DF-A	
MIL-T-5624	JP-5	
ASTM-D-1655	Jet A-1	

Table 7-17 (Continued). Cold Weather Operation.

Recommended Lubricating Oils for Cold Weather			
Temperature Range		Lubricating Oil	
+10 °F to -10 °F		MIL-L-2104E (SAE 10W)Series 3 SAE 10W	
-10 °F to -65 °F		Series 3 SAE 10W SAE 5W/30 SAE 5W/20 MIL-L-46167 (SAE 0W/20)	
NOTE MIL-L-46167 should be used only as a last resort when cranking is a severe problem and auxiliary heating aids are not available.			
Recommended Gear Oil Types at Various Temperatures			
Expected Temperature Range	MIL-2105D Classification	SAE Grade Equivalent	NATO Code
-70 °F to 50 °F	GO 75	SAE 75W	O-186
-20 °F to 120 °F	GO 80/90	SAE 80W/90	O-226
5 °F to 120 °F	GO 85/140	SAE 85W/140	O-228
NOTE Hydraulic oil should conform to MIL-O-5606. A suitable commercial substitute is CHEVRON SUB ZERO SAE 5W/20 hydraulic oil.			

7-7 SALVAGE SURVEY

Table 7-18. Salvage Survey Checklist, General.

Type of casualty:	
Date/time of casualty:	
Ship's name	
Hull type:	
Builder:	Year:
Flag:	
Hull or Pennant # (Naval)/ Official # & Builder's # (Merchant):	
Homeport:	
Planning Yard (USN):	
Owner:	
ISIC (Naval)/Agent (merchant):	
Local Contact:	
Location (area name):	
(coordinates):	
Nearest Port:	Distance:
Nearest U.S. or Allied Naval facility:	
Nearest major U.S. or Allied Naval station or repair facility:	
Crew Status:	
Hazardous Cargo?	Spill:
Oil spill or other pollution occurred or likely?	

Table 7-18 (continued). Salvage Survey Checklist, General.

Principal characteristics of casualty:		
LBP:	LOA:	Beam:
Normal service draft:		
Displacement:	Light ship/Full Load:	
Deadweight:		
Number of Tanks/Holds:		
Propulsion:		
Framing system/significant structural details:		
Brief description of casualty, pre-casualty condition, cargo load, major damage, and ship's overall condition:		
Damage (hull/structural):		
Machinery (condition/status):		
Flooding:		
Fire:		
Aim/intent of salvage operation:		
Available Assets:		
On-scene:		
In-area:		

Table 7-18 (continued). Salvage Survey Checklist, General.

Other assets (with estimated transit time):			
Drawings and documents available:			
General Arrangement	Lines		
Section Scantlings	Shell Expansion		
Offsets	Curves of Form		
DC Book	DC Plates		
Liquid load diagram	Flooding effect diagram		
Draft Diagram	Ships Information Book		
Bonjean's Curves	Structural Plans		
Sounding/Ullage tables	Capacity Plan		
Deadweight Scale	Trim and Stability Book		
Stowage/Load Plan	Cargo Manifest		
Deck Log	Engineer's Log		
Pre-casualty stability information known or available from plans/documents:			
KG	KM	TPI	MTI
Comments:			

Table 7-18 (continued). Salvage Survey Checklist, General.

Drafts:	Before Stranding	After Stranding*	
Forward		port	stbd
Aft		port	stbd
Hog/Sag: (if any)			
Displacement:			
Trim:			
List:			
Heading:			
Engine order:			
Loading Summary:			
Solid cargo			
Liquid cargo			
Fuel			
Lube Oil			
Feed water			
Potable water			
Water ballast			
Permanent ballast			
Ammunition/explosives			
Flooding Summary:			
Course/speed at time of stranding:			
Position of rudder at a stranding:			
* Date, time, state of tide for after draft figures?			
** Maintained for what length of time?			

Table 7-18 (continued). Salvage Survey Checklist, General.

ACTION TAKEN TO DATE		
Action:	Date	Accomplished by
Anchors laid out		
Ship ballasted		
Ship lightened		
Weight shifts/changes:		
Other		
SITE SURVEY		
Casualty exposed to:		
swell:		(height/period)
seas:		(height/period, breaking?)
wind:		(speed/direction)
currents:		(surface, speed/direction)
		(subsurface, speed/direction)
Water Temperature:		
Type and range of tide:		
Bottom:		
material:		
slope:		
topography:		
Beach survey conducted?		
Access:		
to the wreck site:		
to the wreck:		
to beach/shore:		
General Site description:		
exposure:		
weather:		
access to deep water:		

Table 7-18 (continued). Salvage Survey Checklist, General

SITE SURVEY (Continued)			
Weather forecasts available?			
Tide tables available?		Tide gage set up?	
Current predictions available		Current monitored?	
Current effects: Scouring?		Silting/sand buildup	
Accurate large scale chart, recent edition, covering salvage site available?			
Area around casualty and channel to deep water sounded?			
Pollution noted:			
Description:			
Magnitude:			
Source:			
Attach sketch showing position/orientation of casualty relative to shoreline, obstructions, hazards, depth of water; channel to deep water; soundings; any anchors laid out; extent of any pollution and containment efforts, etc.			
EXTERNAL CASUALTY SURVEY			
Date/Time:			
Dive Survey?			
Supervisor:			
Photographs, video tapes, sonar traces, etc., available?			
Aground over what length(s):			
Settled into bottom?		Machinery suction clear?	
Soundings:			
Distance from bow			
Port		Starboard	

Table 7-18 (continued). Salvage Survey Checklist, General.

EXTERNAL CASUALTY SURVEY (Continued)		
External Damage:		
General position/attitude damage:		
Cargo leaking/spilling from hull ruptures:		
Propeller(s) and shaft(s):		
Rudder:		
Hatches and W/T closures (hull and weather decks):		
Attach sketches or copy of arrangement plans showing damage to shell plating, superstructure and decks, mudline, portions of ship aground.		
Potential removable weights:		
Object	Location	Approximate Weight
Lifting points:		
Pulling points:		

Table 7-18 (continued). Salvage Survey Checklist, General.

INTERNAL CASUALTY SURVEY			
Tank soundings/hold inspections: record information on liquid load, cargo, or flooding summary sheets. Verify that conditions are unchanged in undamaged spaces.			
Structural Damage:			
Framing:			
Tank Tops:			
Hatches/Doors:			
Piping Systems:			
Machinery Spaces			
Significant material available from casualty bo's'un locker/riggers' stores?			
Type:		No. Shafts:	
SHP:		Engines per shaft:	
Status:		Repairable on-site?	
Fuel available?		Salvageable?	

Table 7-18 (continued). Salvage Survey Checklist, General

AUXILIARY MACHINERY SUMMARY				
Item	No. Units	Power Required	Capacity	Status*
Air Compressors:		(cfm/psi)		
Generator Sets:		(kW/volt)		
Boilers:		(lbs/hr.psi)		
Evaporators:		(gal/hr)		
Hydraulic Units:		(gpm/psi)		
Pumps (note type):		(gpm/psi)		
Other (note):				
<p>* STATUS</p> <p>OOO Out of commission, not operable</p> <p>CW Operable, if cooling water can be supplied</p> <p>PWR Operable, but requires power source</p> <p>F Operable, prime mover requires fuel - note fuel type (DFM, No. 2 gas, etc)</p> <p>A1 Fully operable</p> <p>A2 Operable at reduced capability</p>				

Table 7-18 (continued). Salvage Survey Checklist, General.

DECK MACHINERY SUMMARY														
Item	Location	Power Required	Capacity	Status*										
Winches:		(wire/tons)												
Booms/ cranes:		(tons)												
Davits:														
Anchor Windlass:		(anchor)												
Port and stbd units		Cross connected?												
<p>* STATUS</p> <p>OOO Out of commission, not operable</p> <p>CW Operable, if cooling water can be supplied</p> <p>PWR Operable, but requires power source</p> <p>F Operable, prime mover requires fuel - note fuel type (DFM, No. 2 gas, etc)</p> <p>A1 Fully operable</p> <p>A2 Operable at reduced capability</p>														
BOAT SUMMARY														
Location1	Type2	Weight3	Capacity4	Status5										
<p>1 Note whether in skids, davits, or welldeck, fore/aft and p/s position.</p> <p>2 LCM, motor whale boat, etc., note propulsion.</p> <p>3 Weight in tons.</p> <p>4 Pounds cargo/number of personnel.</p> <p>5 Use following codes for boat status and availability:</p> <table style="width: 100%; border: none;"> <tr> <td style="width: 50%;">A1 fully operational</td> <td style="width: 50%;">L1 launchable</td> </tr> <tr> <td>A2 operable at reduced capability</td> <td>L2 launchable, risk of damage</td> </tr> <tr> <td>A3 inoperable propulsion/hull sound</td> <td></td> </tr> <tr> <td>A4 hull damage, repairable</td> <td>L3 crane/boom required</td> </tr> <tr> <td>A5 OOC, beyond repair on site</td> <td>L4 inaccessible</td> </tr> </table>					A1 fully operational	L1 launchable	A2 operable at reduced capability	L2 launchable, risk of damage	A3 inoperable propulsion/hull sound		A4 hull damage, repairable	L3 crane/boom required	A5 OOC, beyond repair on site	L4 inaccessible
A1 fully operational	L1 launchable													
A2 operable at reduced capability	L2 launchable, risk of damage													
A3 inoperable propulsion/hull sound														
A4 hull damage, repairable	L3 crane/boom required													
A5 OOC, beyond repair on site	L4 inaccessible													

Table 7-18 (continued). Salvage Survey Checklist, General.

FLOODING SUMMARY					
Flooding as of		before		after	
Compt	Depth	Weight	LCG-KG-TCG	FS	FC
Total Flooding Weight:					
Comments:					

INDEX

anchors.....	3-31
dragging.....	4-11
fluke angle.....	4-11
ground legs.....	4-19
holding power.....	3-31, 4-26
type.....	3-31
beach gear.....	4-9, 4-10, 4-12, 4-15, 4-22, 4-29, 4-30
blowing.....	5-36, 5-38, 5-39
bollard pull.....	4-9, 4-10, 4-28
breaking strength	
chain stopper and turnbuckle.....	3-20
chain.....	3-10, 3-24
hooks.....	3-38
rope.....	3-4, 3-8
breathing apparatus.....	1-9, 1-15
carbon monoxide.....	1-7
catenary formula.....	7-62
cement gun.....	5-17, 5-20
center of buoyancy.....	2-3, 2-4, 7-20
center of flotation.....	2-3, 2-8, 4-5, 7-20
center of gravity.....	2-4, 7-20
chain	
breaking strength.....	3-10, 3-24, 3-27
connecting hardware.....	3-29, 3-30
detachable links.....	3-29, 6-10
links.....	3-22, 3-24, 3-38
change of draft.....	4-3
CHEMTREC.....	1-4, 1-5
CHRIS.....	1-3, 1-4
Clips.....	3-16, 3-17, 3-18, 3-19, 3-20, 4-18
coefficient of friction.....	4-6, 4-7
coefficients of form.....	2-1, 2-2, 7-19
cofferdams.....	5-42, 5-43
compressors.....	4-13, 5-37, 7-44
concrete.....	5-15, 5-18, 5-19, 5-20, 5-21
conversion	
density.....	7-4
flow rate.....	7-12
power.....	7-11
pressure.....	7-4
temperature.....	7-11
current.....	7-60, 7-61, 7-62

density	
conversion	7-4
liquids	7-42
material.....	7-26
dewatering	1-16, 1-19, 5-28, 5-32, 5-34, 5-40
discharge head	5-28, 5-33, 5-36
displacement	2-3, 2-7, 7-19
draft	2-7, 4-3, 7-23
ESSM	1-2, 1-3, 1-5, 4-16, 6-31
Explosion	1-10, 1-11, 1-12, 1-13
explosive meter.....	1-10
explosives.....	1-12
fire	1-1, 1-12
firefighting.....	1-12, 1-14
flood valves.....	6-43
flooding.....	1-16, 2-4, 2-16, 7-24
flow rate conversion	7-12
force	
current	7-60, 7-62
freeing.....	4-6
wind	7-60
free surface effect	2-9, 7-23
freeing force.....	4-6
gas	
monitoring equipment.....	1-7, 1-10
hazards.....	1-7, 1-10, 1-12
gaskets	5-13, 5-14
generators	7-44
ground leg.....	4-19, 4-20, 4-23, 4-26, 4-27
ground reaction.....	4-6, 4-12, 7-23
hauling force	4-28
hazards.....	1-3, 1-7, 1-5, 5-41
head	5-28, 5-29
heaving.....	4-29
helicopters	7-59
HMIRS	1-4
Hogging	2-17, 4-13, 5-13, 5-14
holding power	3-17, 3-31, 4-26, 5-19, 5-26
hooks.....	3-36, 3-38
hydrogen sulfide	1-7

immediate pull	4-8
impellers	5-30
knots	3-10, 7-6, 7-7, 7-8
lifting	
buoyant	3-44
tidal	3-47
linear pullers.....	4-16
material properties	7-26
measurement systems	
circular	7-4
english	7-2
metric.....	7-1
mechanical advantage	3-41, 3-42
metacenter.....	2-7, 7-21
moment to trim one inch.....	2-8, 4-2, 7-21
naval architecture.....	2-1
coefficients of form	2-1, 2-2, 7-19
formulae.....	7-19
neutral loading point.....	4-4, 7-24
nuts.....	3-17, 3-36, 5-13
OHMTADS.....	1-4
oxygen deficiency.....	1-7, 1-10
patches	
construction.....	5-4
placement	5-11
types	6-13, 6-16
petroleum cargoes	1-11, 7-32, 7-43
plank thickness	5-4
pollution control.....	1-1
pontoons.....	3-43, 3-44, 3-45
poured sockets.....	3-16
pressure.....	1-8, 1-10, 5-3, 5-13, 5-26, 5-36, 7-24
properties of plane surfaces	7-14
properties of solid bodies	7-17
pumping.....	5-28, 5-29, 5-31, 5-33, 5-35
pumps.....	1-3, 5-29, 5-30, 5-31, 7-44
performance curve	7-46
purchase.....	3-41, 4-17
friction	3-41
mechanical advantage	3-41

reeving.....	3-43, 4-21
refloating.....	4-1, 4-7, 4-10
stabilization.....	4-7
restoring watertight envelope.....	1-18
rigging.....	3-1, 3-36, 4-18
rope	
fiber.....	3-1, 3-2, 3-4
wire.....	3-10, 3-11
safety.....	3-8, 3-28
salvage plan.....	1-18
salvage survey.....	1-18, 7-68
shackles.....	3-36
sheave.....	3-14
shoring.....	5-21, 5-22
SIMPSON'S RULES.....	2-18
slings.....	3-39
sockets.....	3-16
splices.....	3-10
stability.....	2-5, 2-9, 2-12, 2-15
steaming.....	1-8
stowage factors.....	7-29
stranding.....	4-1
strength of ships.....	2-16
strongback.....	5-14, 5-26
SWL.....	3-8, 3-11
Trapezoidal Rule.....	2-17
Temperature.....	7-11
tons per inch immersion.....	2-3, 4-2, 7-20
tow wire.....	4-28
towing.....	6-1, 6-7, 6-12
toxicity.....	1-7
trim.....	2-8, 4-1
turnbuckles.....	3-37, 5-15
volatile materials.....	1-12
volume.....	2-3, 7-1, 7-26
waterplane.....	2-2, 2-3, 7-19
weather.....	7-66
weight movement.....	2-13, 4-3
weights.....	2-12
weights and measures.....	7-1
winch.....	7-45
wind.....	7-60

NAVSEA/SPAWAR TECHNICAL MANUAL DEFICIENCY/EVALUATION REPORT (TMDER)**INSTRUCTIONS:** Continue on 8 1/2" x 11" page if additional space is needed.

1. Use this report to indicate deficiencies, problems and recommendations relating to publications.

2. For **NOFORN** TMDERs mailing requirements, see OPNAVINST N9210.3.3. For **CLASSIFIED** TMDERs mailing requirements, see SECNAV M-5510.36.

4. For TMDERs that affect more than one publication, submit a separate TMDER for each.

5. Submit TMDERs at web site <https://nsdsa.dc3n.navy.mil> or mail to: **COMMANDING OFFICER, CODE 310 TMDERs, NAVSURFWARCENDIV NSDSA, 4363 MISSILE WAY BLDG 1389, PORT HUENEME CA 93043-4307**

CLASSIFICATION

1. PUBLICATION NUMBER	2. VOL/PART	3. REV/DATE OR CHG/DATE	4. SYSTEM/EQUIPMENT ID
5. TITLE OF PUBLICATION			6. REPORT CONTROL NUMBER (6 digit UIC-YY-any four: xxxxxx-10-xxxx)
7. RECOMMEND CHANGES TO PUBLICATION			
7a. Page #	7b. Para #	7c. RECOMMENDED CHANGES AND REASONS	
8. ORIGINATOR'S NAME AND WORK CENTER	9. DATE	10. ORIGINATOR'S E-MAIL ADDRESS	11. TMMA of Manual (NSDSA will complete)
12. SHIP OR ACTIVITY Name and Address (Include UIC/CAGE/HULL)		13. Phone Numbers: Commercial () ___-____ DSN ___-____ FAX () ___-____	

FOLD HERE AND TAPE SECURELY
PLEASE DO NOT STAPLE

INCLUDE COMPLETE ADDRESS

USE
PROPER
POSTAGE

FOR OFFICIAL USE ONLY

**COMMANDING OFFICER
CODE 310 TMDERs
NAVSURFWARCENDIV NSDSA
4363 MISSILE WAY BLDG 1389
PORT HUENEME CA 93043-4307**

FOLD HERE AND TAPE SECURELY
PLEASE DO NOT STAPLE